

Prohibition

Symbol	Description	Page	Symbol	Description	Page	Symbol	Description	Page
	P001 : General prohibition sign	111		P019 : No stepping on surface	128		P037 : Do not leave the tow-track	144
	P002 : No smoking	112		P020 : Do not use lift in the event of fire	129		P038 : Do not swing the chair	144
	P002/PIC 900 : No smoking including electronic cigarettes	112		P021 : No dogs	130		P040 : Do not set off fireworks	145
	P003 : No open flame; Fire, open ignition source and smoking prohibited	113		P022 : No eating or drinking	131		P041 : No leaning against	146
	P004 : No thoroughfare	114		P023 : Do not obstruct	132		P042 : Not for pregnant women	147
	P005 : Not drinking water	115		P024 : Do not walk or stand here	133		P043 : Not for people in the state of intoxication	148
	P006 : No access for fork lift trucks and other industrial vehicles	116		P025 : Do not use this incomplete scaffold	134		P044 : Use of smart glasses prohibited	149
	P007 : No access for people with active implanted cardiac devices	117		P026 : Do not use this device in a bathtub, shower or water-filled reservoir	135		P046 : Do not stretch out of toboggan	150
	P008 : No metallic articles or watches	118		P027 : Do not use this lift for people	136		P047 : Do not ram into toboggan	151
	P009 : No climbing	119		P028 : Do not wear gloves	137		PIC 209 (=PIC 2110) : No access for unauthorised persons	152
	P010 : Do not touch	119		P029 : No photography	138		PIC 209 (=PIC 2110) : No access for unauthorised persons	152
	P011 : Do not extinguish with water	120		P030 : Do not tie knots in rope	139		PIC 900 : No smoking of electronic cigarettes	152
	P012 : No heavy load	121		P031 : Do not alter the state of the switch	140		PIC 225 : No parking	153
	P013 : No activated mobile phones	122		P032 : Do not use for face grinding	141		PIC 226 : No Stopping (Clearway)	153
	P014 : No access for persons with metallic implants	123		P033 : Do not use for wet grinding	141		PIC 227 : No waiting	153
	P015 : No reaching in	124		P034 : Do not use with hand-held grinding machine	142		PIC 228 : Prohibited for all types of vehicles	153
	P016 : Do not spray with water	125		P035 : Do not wear metal-studded footwear	143		PIC 229 : No entry	153
	P017 : No pushing	126		P036 : No children allowed	143			
	P018 : No sitting	127						

Complies with EN ISO 7010

P001 : GENERAL PROHIBITION SIGN

The P001 prohibition symbol is the most basic and general. For this reason, it is essential to position it with a key clarifying the ban.



SIGNS

Order Ref.	Diameter (mm)	Total Qty/ Pack
Laminated Polyester		
821845	50	2 / Pack
821847	100	1 / Pack
821848	200	1 / Pack
821849	315	1 / Pack
Polypropylene		
821851	100	1 / Pack
821852	200	1 / Pack
821853	315	1 / Pack
Aluminium		
821855	100	1 / Pack
821856	200	1 / Pack
821857	315	1 / Pack

FLOOR MARKING

Order Ref.	Diameter (mm)	Total Qty/ Pack
Anti-skid Laminated Polyester		
821850	500	1 / Pack

MINI-PICTOGRAMS

Order Ref.	Diameter (mm)	Total Qty/ Pack
Laminated Polyester		
821843	25	7 / Pack
Vinyl		
821841	15	54 / Pack



PICTOGRAMS ON ROLLS

Order Ref.	Diameter (mm)	Total Qty/ Pack
Laminated Polyester		
821842	25	250 / Roll
821844	50	250 / Roll
821846	100	250 / Roll

i For all material properties and applications, see pages 4-5

BRADY Customise-it See page 196 to order your custom-made signs.



The P001 prohibition symbol is the most basic and general. For this reason, it is essential to position it with a key clarifying the ban.



P002 : No SMOKING

Widely used symbol in numerous environments, public and private.



SIGNS

Order Ref.	Diameter (mm)	Total Qty/ Pack
Laminated Polyester		
821994	50	2 / Pack
821996	100	1 / Pack
821997	200	1 / Pack
821998	315	1 / Pack
Polypropylene		
822000	100	1 / Pack
822001	200	1 / Pack
822002	315	1 / Pack
822003	400	1 / Pack
Aluminium		
822004	100	1 / Pack
822005	200	1 / Pack
822006	315	1 / Pack

FLOOR MARKING

Order Ref.	Diameter (mm)	Total Qty/ Pack
Anti-skid Laminated Polyester		
821999	500	1 / Pack

MINI-PICTOGRAMS

Order Ref.	Diameter (mm)	Total Qty/ Pack
Laminated Polyester		
138973	20	18 / Pack
821992	25	7 / Pack
Vinyl		
821990	15	54 / Pack



PICTOGRAMS ON ROLLS

Order Ref.	Diameter (mm)	Total Qty/ Pack
Laminated Polyester		
821991	25	250 / Roll
821993	50	250 / Roll
821995	100	250 / Roll

SIGNS WITH TEXT



Order Ref.	Width (mm)	Height (mm)	Layout	Legend	Total Qty/ Pack
Polypropylene					
822062	150	50	Landscape	No smoking	1 / Pack
822063	297	74	Landscape	No smoking	1 / Pack
822065	450	150	Landscape	No smoking	1 / Pack
822066	600	200	Landscape	No smoking	1 / Pack
822059	148	210	Portrait	No smoking	1 / Pack
822060	210	297	Portrait	No smoking	1 / Pack
822064	297	105	Portrait	No smoking	1 / Pack
822061	297	420	Portrait	No smoking	1 / Pack
Aluminium					
822070	150	50	Landscape	No smoking	1 / Pack
822072	450	150	Landscape	No smoking	1 / Pack
822067	148	210	Portrait	No smoking	1 / Pack
822068	210	297	Portrait	No smoking	1 / Pack
822071	297	105	Portrait	No smoking	1 / Pack
822069	297	420	Portrait	No smoking	1 / Pack
Laminated Polyester					
822054	150	50	Landscape	No smoking	1 / Pack
822055	297	74	Landscape	No smoking	1 / Pack
822057	450	150	Landscape	No smoking	1 / Pack
822058	600	200	Landscape	No smoking	1 / Pack
822051	148	210	Portrait	No smoking	1 / Pack
822052	210	297	Portrait	No smoking	1 / Pack
822056	297	105	Portrait	No smoking	1 / Pack
822053	297	420	Portrait	No smoking	1 / Pack



P002/PIC 900 : No SMOKING INCLUDING ELECTRONIC CIGARETTES

With the arrival of electronic cigarettes, these signs can indicate that they are prohibited on your premises.



SIGNS

Order Ref.	Width (mm)	Height (mm)	Total Qty/ Pack
Laminated Polyester			
138506	200	100	1 / Pack

i PIC 900 is also available separately. See page 152.

SIGNS WITH TEXT



Order Ref.	Width (mm)	Height (mm)	Legend	Total Qty/ Pack
Laminated Polyester				
138507	420	297	No smoking including electronic cigarettes	1 / Pack
Polypropylene				
138515	420	297	No smoking including electronic cigarettes	1 / Pack

Complies with EN ISO 7010

P003 : No OPEN FLAME; FIRE, OPEN IGNITION SOURCE AND SMOKING PROHIBITED

Symbol used in a sensitive environment, where the smallest flame may be dangerous.



SIGNS

Order Ref.	Diameter (mm)	Total Qty/Pack
Laminated Polyester		
822143	50	2 / Pack
822145	100	1 / Pack
822146	200	1 / Pack
822147	315	1 / Pack
Polypropylene		
822149	100	1 / Pack
822150	200	1 / Pack
822151	315	1 / Pack
Aluminium		
822153	100	1 / Pack
822154	200	1 / Pack
822155	315	1 / Pack

FLOOR MARKING

Order Ref.	Diameter (mm)	Total Qty/Pack
Anti-skid Laminated Polyester		
822148	500	1 / Pack

MINI-PICTOGRAMS

Order Ref.	Diameter (mm)	Total Qty/Pack
Laminated Polyester		
822141	25	7 / Pack
Vinyl		
822139	15	54 / Pack



PICTOGRAMS ON ROLLS

Order Ref.	Diameter (mm)	Total Qty/Pack
Laminated Polyester		
822140	25	250 / Roll
822142	50	250 / Roll
822144	100	250 / Roll



PHOTOLUMINESCENT SIGNS

Order Ref.	Diameter (mm)	Class	Total Qty/Pack
Class B Photoluminescent Polyester			
836759	200	Class B	1 / Pack
Class B Photoluminescent Polypropylene			
836755	200	Class B	1 / Pack
836758	300	Class B	1 / Pack

SIGNS WITH TEXT



Order Ref.	Width (mm)	Height (mm)	Layout	Legend	Total Qty/Pack
Polypropylene					
822211	150	50	Landscape	No open flame; Fire, open ignition source and smoking prohibited	1 / Pack
822212	297	74	Landscape	No open flame; Fire, open ignition source and smoking prohibited	1 / Pack
822214	450	150	Landscape	No open flame; Fire, open ignition source and smoking prohibited	1 / Pack
822215	600	200	Landscape	No open flame; Fire, open ignition source and smoking prohibited	1 / Pack
822208	148	210	Portrait	No open flame; Fire, open ignition source and smoking prohibited	1 / Pack
822209	210	297	Portrait	No open flame; Fire, open ignition source and smoking prohibited	1 / Pack
822213	297	105	Portrait	No open flame; Fire, open ignition source and smoking prohibited	1 / Pack
822210	297	420	Portrait	No open flame; Fire, open ignition source and smoking prohibited	1 / Pack
Aluminium					
822219	150	50	Landscape	No open flame; Fire, open ignition source and smoking prohibited	1 / Pack
822221	450	150	Landscape	No open flame; Fire, open ignition source and smoking prohibited	1 / Pack
822216	148	210	Portrait	No open flame; Fire, open ignition source and smoking prohibited	1 / Pack
822217	210	297	Portrait	No open flame; Fire, open ignition source and smoking prohibited	1 / Pack
822220	297	105	Portrait	No open flame; Fire, open ignition source and smoking prohibited	1 / Pack
822218	297	420	Portrait	No open flame; Fire, open ignition source and smoking prohibited	1 / Pack
Laminated Polyester					
822203	150	50	Landscape	No open flame; Fire, open ignition source and smoking prohibited	1 / Pack
822204	297	74	Landscape	No open flame; Fire, open ignition source and smoking prohibited	1 / Pack
822206	450	150	Landscape	No open flame; Fire, open ignition source and smoking prohibited	1 / Pack
822207	600	200	Landscape	No open flame; Fire, open ignition source and smoking prohibited	1 / Pack
822200	148	210	Portrait	No open flame; Fire, open ignition source and smoking prohibited	1 / Pack
822201	210	297	Portrait	No open flame; Fire, open ignition source and smoking prohibited	1 / Pack
822205	297	105	Portrait	No open flame; Fire, open ignition source and smoking prohibited	1 / Pack
822202	297	420	Portrait	No open flame; Fire, open ignition source and smoking prohibited	1 / Pack

i For all material properties and applications, see pages 4-5

BRADY Customise-it See page 196 to order your custom-made signs.



P004 : No THOROUGHFARE

To protect pedestrians, it is important to indicate the passageways which are prohibited for pedestrians, as well as those which are authorised (M024, page 178) for better coexistence of pedestrians and machines.



SIGNS

Order Ref.	Diameter (mm)	Total Qty/Pack
Laminated Polyester		
822292	50	2 / Pack
822294	100	1 / Pack
822295	200	1 / Pack
822296	315	1 / Pack
Polypropylene		
822298	100	1 / Pack
822299	200	1 / Pack
822300	315	1 / Pack
Aluminium		
822302	100	1 / Pack
822303	200	1 / Pack
822304	315	1 / Pack

FLOOR MARKING

Order Ref.	Diameter (mm)	Total Qty/Pack
Anti-skid Laminated Polyester		
822297	500	1 / Pack

MINI-PICTOGRAMS

Order Ref.	Diameter (mm)	Total Qty/Pack
Laminated Polyester		
822290	25	7 / Pack
Vinyl		
822288	15	54 / Pack

SIGNS WITH TEXT



Order Ref.	Width (mm)	Height (mm)	Layout	Legend	Total Qty/Pack
Polypropylene					
822360	150	50	Landscape	No thoroughfare	1 / Pack
822361	297	74	Landscape	No thoroughfare	1 / Pack
822363	450	150	Landscape	No thoroughfare	1 / Pack
822364	600	200	Landscape	No thoroughfare	1 / Pack
822357	148	210	Portrait	No thoroughfare	1 / Pack
822358	210	297	Portrait	No thoroughfare	1 / Pack
822362	297	105	Portrait	No thoroughfare	1 / Pack
822359	297	420	Portrait	No thoroughfare	1 / Pack
Aluminium					
822368	150	50	Landscape	No thoroughfare	1 / Pack
822370	450	150	Landscape	No thoroughfare	1 / Pack
822365	148	210	Portrait	No thoroughfare	1 / Pack
822366	210	297	Portrait	No thoroughfare	1 / Pack
822369	297	105	Portrait	No thoroughfare	1 / Pack
822367	297	420	Portrait	No thoroughfare	1 / Pack
Laminated Polyester					
822352	150	50	Landscape	No thoroughfare	1 / Pack
822353	297	74	Landscape	No thoroughfare	1 / Pack
822355	450	150	Landscape	No thoroughfare	1 / Pack
822356	600	200	Landscape	No thoroughfare	1 / Pack
822349	148	210	Portrait	No thoroughfare	1 / Pack
822350	210	297	Portrait	No thoroughfare	1 / Pack
822354	297	105	Portrait	No thoroughfare	1 / Pack
822351	297	420	Portrait	No thoroughfare	1 / Pack



PICTOGRAMS ON ROLLS

Order Ref.	Diameter (mm)	Total Qty/Pack
Laminated Polyester		
822289	25	250 / Roll
822291	50	250 / Roll
822293	100	250 / Roll



PHOTOLUMINESCENT SIGNS

Order Ref.	Diameter (mm)	Class	Total Qty/Pack
Class B Photoluminescent Polyester			
835909	150	Class B	1 / Pack
Class C Photoluminescent Polyester			
835912	150	Class C	1 / Pack
Class B Photoluminescent Polypropylene			
835906	150	Class B	1 / Pack
Class C Photoluminescent Polypropylene			
835908	150	Class C	1 / Pack
Class C Photoluminescent Aluminium			
835905	150	Class C	1 / Pack

Complies with EN ISO 7010

P005 : NOT DRINKING WATER

Pointing out that water is not drinkable is crucial. This can avoid an infection due to water unsuitable for consumption.



SIGNS

Order Ref.	Diameter (mm)	Total Qty/Pack
Laminated Polyester		
822441	50	2 / Pack
822443	100	1 / Pack
822444	200	1 / Pack
822445	315	1 / Pack
Polypropylene		
822447	100	1 / Pack
822448	200	1 / Pack
822449	315	1 / Pack
Aluminium		
822451	100	1 / Pack
822452	200	1 / Pack
822453	315	1 / Pack

FLOOR MARKING

Order Ref.	Diameter (mm)	Total Qty/Pack
Anti-skid Laminated Polyester		
822446	500	1 / Pack

MINI-PICTOGRAMS

Order Ref.	Diameter (mm)	Total Qty/Pack
Laminated Polyester		
822439	25	7 / Pack
138978	30	15 / Pack
Vinyl		
822437	15	54 / Pack



PICTOGRAMS ON ROLLS

Order Ref.	Diameter (mm)	Total Qty/Pack
Laminated Polyester		
822438	25	250 / Roll
822440	50	250 / Roll
822442	100	250 / Roll

SIGNS WITH TEXT



Order Ref.	Width (mm)	Height (mm)	Layout	Legend	Total Qty/Pack
Polypropylene					
822509	150	50	Landscape	Not drinking water	1 / Pack
822510	297	74	Landscape	Not drinking water	1 / Pack
822512	450	150	Landscape	Not drinking water	1 / Pack
822513	600	200	Landscape	Not drinking water	1 / Pack
822506	148	210	Portrait	Not drinking water	1 / Pack
822507	210	297	Portrait	Not drinking water	1 / Pack
822511	297	105	Portrait	Not drinking water	1 / Pack
822508	297	420	Portrait	Not drinking water	1 / Pack
Aluminium					
822517	150	50	Landscape	Not drinking water	1 / Pack
822519	450	150	Landscape	Not drinking water	1 / Pack
822514	148	210	Portrait	Not drinking water	1 / Pack
822515	210	297	Portrait	Not drinking water	1 / Pack
822518	297	105	Portrait	Not drinking water	1 / Pack
822516	297	420	Portrait	Not drinking water	1 / Pack
Laminated Polyester					
822501	150	50	Landscape	Not drinking water	1 / Pack
822502	297	74	Landscape	Not drinking water	1 / Pack
822504	450	150	Landscape	Not drinking water	1 / Pack
822505	600	200	Landscape	Not drinking water	1 / Pack
822498	148	210	Portrait	Not drinking water	1 / Pack
822499	210	297	Portrait	Not drinking water	1 / Pack
822503	297	105	Portrait	Not drinking water	1 / Pack
822500	297	420	Portrait	Not drinking water	1 / Pack

i For all material properties and applications, see pages 4-5

BRADY Customise-it See page 196 to order your custom-made signs.



BRADY
WHICH PERFORMANCE BATTERS MOST?

Pipe Marking
Have a clear understanding of what is running through your pipes

Correct identification of pipes guarantees a better overview of a building's structure. Accidents, injuries and damage can be avoided. Contact your Brady distributor to find out more about our full range of pipe markers.



P006 : No Access for Fork Lift Trucks and Other Industrial Vehicles

To make the coexistence of pedestrians and drivers easier in an environment, the rules must be clear and indicated. This symbol indicates a zone prohibited for drivers.



SIGNS

Order Ref.	Diameter (mm)	Total Qty/Pack
Laminated Polyester		
822590	50	2 / Pack
822592	100	1 / Pack
822593	200	1 / Pack
822594	315	1 / Pack
Polypropylene		
822596	100	1 / Pack
822597	200	1 / Pack
822598	315	1 / Pack
822599	400	1 / Pack
Aluminium		
822600	100	1 / Pack
822601	200	1 / Pack
822602	315	1 / Pack

FLOOR MARKING

Order Ref.	Diameter (mm)	Total Qty/Pack
Anti-skid Laminated Polyester		
822595	500	1 / Pack

MINI-PICTOGRAMS

Order Ref.	Diameter (mm)	Total Qty/Pack
Laminated Polyester		
822588	25	7 / Pack
Vinyl		
822586	15	54 / Pack



PICTOGRAMS ON ROLLS

Order Ref.	Diameter (mm)	Total Qty/Pack
Laminated Polyester		
822587	25	250 / Roll
822589	50	250 / Roll
822591	100	250 / Roll



SIGNS WITH TEXT



Order Ref.	Width (mm)	Height (mm)	Layout	Legend	Total Qty/Pack
Polypropylene					
822658	150	50	Landscape	No access for fork lift trucks and other industrial vehicles	1 / Pack
822659	297	74	Landscape	No access for fork lift trucks and other industrial vehicles	1 / Pack
822661	450	150	Landscape	No access for fork lift trucks and other industrial vehicles	1 / Pack
822662	600	200	Landscape	No access for fork lift trucks and other industrial vehicles	1 / Pack
822655	148	210	Portrait	No access for fork lift trucks and other industrial vehicles	1 / Pack
822656	210	297	Portrait	No access for fork lift trucks and other industrial vehicles	1 / Pack
822660	297	105	Portrait	No access for fork lift trucks and other industrial vehicles	1 / Pack
822657	297	420	Portrait	No access for fork lift trucks and other industrial vehicles	1 / Pack
Aluminium					
822666	150	50	Landscape	No access for fork lift trucks and other industrial vehicles	1 / Pack
822668	450	150	Landscape	No access for fork lift trucks and other industrial vehicles	1 / Pack
822663	148	210	Portrait	No access for fork lift trucks and other industrial vehicles	1 / Pack
822664	210	297	Portrait	No access for fork lift trucks and other industrial vehicles	1 / Pack
822667	297	105	Portrait	No access for fork lift trucks and other industrial vehicles	1 / Pack
822665	297	420	Portrait	No access for fork lift trucks and other industrial vehicles	1 / Pack
Laminated Polyester					
822650	150	50	Landscape	No access for fork lift trucks and other industrial vehicles	1 / Pack
822651	297	74	Landscape	No access for fork lift trucks and other industrial vehicles	1 / Pack
822653	450	150	Landscape	No access for fork lift trucks and other industrial vehicles	1 / Pack
822654	600	200	Landscape	No access for fork lift trucks and other industrial vehicles	1 / Pack
822647	148	210	Portrait	No access for fork lift trucks and other industrial vehicles	1 / Pack
822648	210	297	Portrait	No access for fork lift trucks and other industrial vehicles	1 / Pack
822652	297	105	Portrait	No access for fork lift trucks and other industrial vehicles	1 / Pack
822649	297	420	Portrait	No access for fork lift trucks and other industrial vehicles	1 / Pack

i For all material properties and applications, see pages 4-5

BRADY Customise-it See page 196 to order your custom-made signs.

Complies with EN ISO 7010

PO07 : No Access for People with Active Implanted Cardiac Devices

Certain environments and activities are prohibited for people wearing a pacemaker to preserve their safety. Pointing these out is therefore vital.



SIGNS

Order Ref.	Diameter (mm)	Total Qty/Pack
Laminated Polyester		
822739	50	2 / Pack
822741	100	1 / Pack
822742	200	1 / Pack
822743	315	1 / Pack
Polypropylene		
822745	100	1 / Pack
822746	200	1 / Pack
822747	315	1 / Pack
Aluminium		
822749	100	1 / Pack
822750	200	1 / Pack
822751	315	1 / Pack

FLOOR MARKING

Order Ref.	Diameter (mm)	Total Qty/Pack
Anti-skid Laminated Polyester		
822744	500	1 / Pack

MINI-PICTOGRAMS

Order Ref.	Diameter (mm)	Total Qty/Pack
Laminated Polyester		
822737	25	7 / Pack
Vinyl		
822735	15	54 / Pack



PICTOGRAMS ON ROLLS

Order Ref.	Diameter (mm)	Total Qty/Pack
Laminated Polyester		
822736	25	250 / Roll
822738	50	250 / Roll
822740	100	250 / Roll

SIGNS WITH TEXT



Order Ref.	Width (mm)	Height (mm)	Layout	Legend	Total Qty/Pack
Polypropylene					
822807	150	50	Land-scape	No access for people with active implanted cardiac devices	1 / Pack
822808	297	74	Land-scape	No access for people with active implanted cardiac devices	1 / Pack
822810	450	150	Land-scape	No access for people with active implanted cardiac devices	1 / Pack
822811	600	200	Land-scape	No access for people with active implanted cardiac devices	1 / Pack
822804	148	210	Portrait	No access for people with active implanted cardiac devices	1 / Pack
822805	210	297	Portrait	No access for people with active implanted cardiac devices	1 / Pack
822809	297	105	Portrait	No access for people with active implanted cardiac devices	1 / Pack
822806	297	420	Portrait	No access for people with active implanted cardiac devices	1 / Pack
Aluminium					
822815	150	50	Land-scape	No access for people with active implanted cardiac devices	1 / Pack
822817	450	150	Land-scape	No access for people with active implanted cardiac devices	1 / Pack
822812	148	210	Portrait	No access for people with active implanted cardiac devices	1 / Pack
822813	210	297	Portrait	No access for people with active implanted cardiac devices	1 / Pack
822816	297	105	Portrait	No access for people with active implanted cardiac devices	1 / Pack
822814	297	420	Portrait	No access for people with active implanted cardiac devices	1 / Pack
Laminated Polyester					
822799	150	50	Land-scape	No access for people with active implanted cardiac devices	1 / Pack
822800	297	74	Land-scape	No access for people with active implanted cardiac devices	1 / Pack
822802	450	150	Land-scape	No access for people with active implanted cardiac devices	1 / Pack
822803	600	200	Land-scape	No access for people with active implanted cardiac devices	1 / Pack
822796	148	210	Portrait	No access for people with active implanted cardiac devices	1 / Pack
822797	210	297	Portrait	No access for people with active implanted cardiac devices	1 / Pack
822801	297	105	Portrait	No access for people with active implanted cardiac devices	1 / Pack
822798	297	420	Portrait	No access for people with active implanted cardiac devices	1 / Pack

i For all material properties and applications, see pages 4-5

BRADY Customise-it See page 196 to order your custom-made signs.



PHOTOLUMINESCENT SIGNS

Order Ref.	Diameter (mm)	Class	Total Qty/Pack
Class B Photoluminescent Polyester			
835924	150	Class B	1 / Pack
Class C Photoluminescent Polyester			
835925	150	Class C	1 / Pack
Class B Photoluminescent Polypropylene			
835922	150	Class B	1 / Pack
Class C Photoluminescent Polypropylene			
835923	150	Class C	1 / Pack
Class C Photoluminescent Aluminium			
835921	150	Class C	1 / Pack



P008 : No METALLIC ARTICLES OR WATCHES

Metallic objects are sometimes banned, for example to ensure the correct operation of some machines.



SIGNS

Order Ref.	Diameter (mm)	Total Qty/Pack
Laminated Polyester		
822888	50	2 / Pack
822890	100	1 / Pack
822891	200	1 / Pack
822892	315	1 / Pack
Polypropylene		
822894	100	1 / Pack
822895	200	1 / Pack
822896	315	1 / Pack
Aluminium		
822898	100	1 / Pack
822899	200	1 / Pack
822900	315	1 / Pack

MINI-PICTOGRAMS

Order Ref.	Diameter (mm)	Total Qty/Pack
Laminated Polyester		
822886	25	7 / Pack
Vinyl		
822884	15	54 / Pack

SIGNS WITH TEXT



Order Ref.	Width (mm)	Height (mm)	Layout	Legend	Total Qty/Pack
Polypropylene					
822956	150	50	Landscape	No metallic articles or watches	1 / Pack
822957	297	74	Landscape	No metallic articles or watches	1 / Pack
822959	450	150	Landscape	No metallic articles or watches	1 / Pack
822960	600	200	Landscape	No metallic articles or watches	1 / Pack
822953	148	210	Portrait	No metallic articles or watches	1 / Pack
822954	210	297	Portrait	No metallic articles or watches	1 / Pack
822958	297	105	Portrait	No metallic articles or watches	1 / Pack
822955	297	420	Portrait	No metallic articles or watches	1 / Pack
Aluminium					
822964	150	50	Landscape	No metallic articles or watches	1 / Pack
822966	450	150	Landscape	No metallic articles or watches	1 / Pack
822961	148	210	Portrait	No metallic articles or watches	1 / Pack
822962	210	297	Portrait	No metallic articles or watches	1 / Pack
822965	297	105	Portrait	No metallic articles or watches	1 / Pack
822963	297	420	Portrait	No metallic articles or watches	1 / Pack
Laminated Polyester					
822948	150	50	Landscape	No metallic articles or watches	1 / Pack
822949	297	74	Landscape	No metallic articles or watches	1 / Pack
822951	450	150	Landscape	No metallic articles or watches	1 / Pack
822952	600	200	Landscape	No metallic articles or watches	1 / Pack
822945	148	210	Portrait	No metallic articles or watches	1 / Pack
822946	210	297	Portrait	No metallic articles or watches	1 / Pack
822950	297	105	Portrait	No metallic articles or watches	1 / Pack
822947	297	420	Portrait	No metallic articles or watches	1 / Pack



PICTOGRAMS ON ROLLS

Order Ref.	Diameter (mm)	Total Qty/Pack
Laminated Polyester		
822885	25	250 / Roll
822887	50	250 / Roll
822889	100	250 / Roll



PHOTOLUMINESCENT SIGNS

Order Ref.	Diameter (mm)	Class	Total Qty/Pack
Class B Photoluminescent Polyester			
835930	150	Class B	1 / Pack
Class C Photoluminescent Polyester			
835931	150	Class C	1 / Pack
Class B Photoluminescent Polypropylene			
835927	150	Class B	1 / Pack
Class C Photoluminescent Polypropylene			
835929	150	Class C	1 / Pack
Class C Photoluminescent Aluminium			
835926	150	Class C	1 / Pack

i For all material properties and applications, see pages 4-5

BRADY Customise-it See page 196 to order your custom-made signs.

Complies with EN ISO 7010

P009 : No CLIMBING

To avoid any falls or damage to equipment, a sign banning climbing must sometimes be put up.



SIGNS

Order Ref.	Diameter (mm)	Total Qty/Pack
Laminated Polyester		
135747	100	1 / Pack
135748	150	1 / Pack
135749	200	1 / Pack
138840	315	1 / Pack
Polypropylene		
135741	100	1 / Pack
135742	150	1 / Pack
135743	200	1 / Pack
138894	315	1 / Pack
Aluminium		
135744	100	1 / Pack
135745	150	1 / Pack
135746	200	1 / Pack



PHOTOLUMINESCENT SIGNS

Order Ref.	Diameter (mm)	Class	Total Qty/Pack
Class B Photoluminescent Polyester			
135756	100	Class B	1 / Pack
135757	150	Class B	1 / Pack
135758	200	Class B	1 / Pack
Class C Photoluminescent Polyester			
135765	100	Class C	1 / Pack
135766	150	Class C	1 / Pack
135767	200	Class C	1 / Pack
Class B Photoluminescent Polypropylene			
135750	100	Class B	1 / Pack
135751	150	Class B	1 / Pack
135752	200	Class B	1 / Pack
Class C Photoluminescent Polypropylene			
135759	100	Class C	1 / Pack
135760	150	Class C	1 / Pack
135761	200	Class C	1 / Pack
Class C Photoluminescent Aluminium			
135762	100	Class C	1 / Pack
135763	150	Class C	1 / Pack
135764	200	Class C	1 / Pack

Complies with EN ISO 7010

P010 : Do NOT TOUCH

Prohibiting touching can be indicated for various reasons: avoiding an injury, preventing fragile objects from being touched etc.



SIGNS

Order Ref.	Diameter (mm)	Total Qty/Pack
Laminated Polyester		
823037	50	2 / Pack
823039	100	1 / Pack
823040	200	1 / Pack
823041	315	1 / Pack
Polypropylene		
823043	100	1 / Pack
823044	200	1 / Pack
823045	315	1 / Pack
Aluminium		
823047	100	1 / Pack
823048	200	1 / Pack
823049	315	1 / Pack

SIGNS WITH TEXT



Order Ref.	Width (mm)	Height (mm)	Layout	Legend	Total Qty/Pack
Polypropylene					
823105	150	50	Landscape	Do not touch	1 / Pack
823106	297	74	Landscape	Do not touch	1 / Pack
823108	450	150	Landscape	Do not touch	1 / Pack
823109	600	200	Landscape	Do not touch	1 / Pack
823102	148	210	Portrait	Do not touch	1 / Pack
823103	210	297	Portrait	Do not touch	1 / Pack
823107	297	105	Portrait	Do not touch	1 / Pack
823104	297	420	Portrait	Do not touch	1 / Pack
Aluminium					
823113	150	50	Landscape	Do not touch	1 / Pack
823115	450	150	Landscape	Do not touch	1 / Pack
823110	148	210	Portrait	Do not touch	1 / Pack
823111	210	297	Portrait	Do not touch	1 / Pack
823114	297	105	Portrait	Do not touch	1 / Pack
823112	297	420	Portrait	Do not touch	1 / Pack
Laminated Polyester					
823097	150	50	Landscape	Do not touch	1 / Pack
823098	297	74	Landscape	Do not touch	1 / Pack
823100	450	150	Landscape	Do not touch	1 / Pack
823101	600	200	Landscape	Do not touch	1 / Pack
823094	148	210	Portrait	Do not touch	1 / Pack
823095	210	297	Portrait	Do not touch	1 / Pack
823099	297	105	Portrait	Do not touch	1 / Pack
823096	297	420	Portrait	Do not touch	1 / Pack

MINI-PICTOGRAMS

Order Ref.	Diameter (mm)	Total Qty/Pack
Laminated Polyester		
823035	25	7 / Pack
Vinyl		
823033	15	54 / Pack

PHOTOLUMINESCENT SIGNS

Order Ref.	Diameter (mm)	Class	Total Qty/Pack
Class B Photoluminescent Polyester			
835936	150	Class B	1 / Pack
Class C Photoluminescent Polyester			
835937	150	Class C	1 / Pack
Class B Photoluminescent Polypropylene			
835934	150	Class B	1 / Pack
Class C Photoluminescent Polypropylene			
835935	150	Class C	1 / Pack
Class C Photoluminescent Aluminium			
835933	150	Class C	1 / Pack



PICTOGRAMS ON ROLLS

Order Ref.	Diameter (mm)	Total Qty/Pack
Laminated Polyester		
823034	25	250 / Roll
823036	50	250 / Roll
823038	100	250 / Roll



P011 : Do NOT EXTINGUISH WITH WATER

Some fires must absolutely not be put out with water, at the risk of worsening the situation.



SIGNS

Order Ref.	Diameter (mm)	Total Qty/Pack
Laminated Polyester		
823186	50	2 / Pack
823188	100	1 / Pack
823189	200	1 / Pack
823190	315	1 / Pack
Polypropylene		
823192	100	1 / Pack
823193	200	1 / Pack
823194	315	1 / Pack
Aluminium		
823196	100	1 / Pack
823197	200	1 / Pack
823198	315	1 / Pack

FLOOR MARKING

Order Ref.	Diameter (mm)	Total Qty/Pack
Anti-skid Laminated Polyester		
823191	500	1 / Pack

MINI-PICTOGRAMS

Order Ref.	Diameter (mm)	Total Qty/Pack
Laminated Polyester		
823184	25	7 / Pack
Vinyl		
823182	15	54 / Pack

SIGNS WITH TEXT



Order Ref.	Width (mm)	Height (mm)	Layout	Legend	Total Qty/Pack
Polypropylene					
823254	150	50	Landscape	Do not extinguish with water	1 / Pack
823255	297	74	Landscape	Do not extinguish with water	1 / Pack
823257	450	150	Landscape	Do not extinguish with water	1 / Pack
823258	600	200	Landscape	Do not extinguish with water	1 / Pack
823251	148	210	Portrait	Do not extinguish with water	1 / Pack
823252	210	297	Portrait	Do not extinguish with water	1 / Pack
823256	297	105	Portrait	Do not extinguish with water	1 / Pack
823253	297	420	Portrait	Do not extinguish with water	1 / Pack
Aluminium					
823262	150	50	Landscape	Do not extinguish with water	1 / Pack
823264	450	150	Landscape	Do not extinguish with water	1 / Pack
823259	148	210	Portrait	Do not extinguish with water	1 / Pack
823260	210	297	Portrait	Do not extinguish with water	1 / Pack
823263	297	105	Portrait	Do not extinguish with water	1 / Pack
823261	297	420	Portrait	Do not extinguish with water	1 / Pack
Laminated Polyester					
823246	150	50	Landscape	Do not extinguish with water	1 / Pack
823247	297	74	Landscape	Do not extinguish with water	1 / Pack
823249	450	150	Landscape	Do not extinguish with water	1 / Pack
823250	600	200	Landscape	Do not extinguish with water	1 / Pack
823243	148	210	Portrait	Do not extinguish with water	1 / Pack
823244	210	297	Portrait	Do not extinguish with water	1 / Pack
823248	297	105	Portrait	Do not extinguish with water	1 / Pack
823245	297	420	Portrait	Do not extinguish with water	1 / Pack



PICTOGRAMS ON ROLLS

Order Ref.	Diameter (mm)	Total Qty/Pack
Laminated Polyester		
823183	25	250 / Roll
823185	50	250 / Roll
823187	100	250 / Roll



PHOTOLUMINESCENT SIGNS

Order Ref.	Diameter (mm)	Class	Total Qty/Pack
Class B Photoluminescent Polyester			
835941	150	Class B	1 / Pack
Class C Photoluminescent Polyester			
835942	150	Class C	1 / Pack
Class B Photoluminescent Polypropylene			
835939	150	Class B	1 / Pack
Class C Photoluminescent Polypropylene			
835940	150	Class C	1 / Pack
Class C Photoluminescent Aluminium			
835938	150	Class C	1 / Pack

i For all material properties and applications, see pages 4-5

BRADY Customise-it See page 196 to order your custom-made signs.

Complies with EN ISO 7010

P012 : No HEAVY LOAD

Placing heavy loads in unsuitable locations can have detrimental consequences. This symbol helps to avoid regrettable situations.



SIGNS

Order Ref.	Diameter (mm)	Total Qty/Pack
Laminated Polyester		
823335	50	2 / Pack
823337	100	1 / Pack
823338	200	1 / Pack
823339	315	1 / Pack
Polypropylene		
823341	100	1 / Pack
823342	200	1 / Pack
823343	315	1 / Pack
Aluminium		
823345	100	1 / Pack
823346	200	1 / Pack
823347	315	1 / Pack

MINI-PICTOGRAMS

Order Ref.	Diameter (mm)	Total Qty/Pack
Laminated Polyester		
823333	25	7 / Pack
138987	30	15 / Pack
Vinyl		
823331	15	54 / Pack



PICTOGRAMS ON ROLLS

Order Ref.	Diameter (mm)	Total Qty/Pack
Laminated Polyester		
823332	25	250 / Roll
823334	50	250 / Roll
823336	100	250 / Roll

SIGNS WITH TEXT

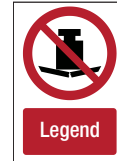

Order Ref.	Width (mm)	Height (mm)	Layout	Legend	Total Qty/Pack
Polypropylene					
823403	150	50	Landscape	No heavy load	1 / Pack
823404	297	74	Landscape	No heavy load	1 / Pack
823406	450	150	Landscape	No heavy load	1 / Pack
823407	600	200	Landscape	No heavy load	1 / Pack
823400	148	210	Portrait	No heavy load	1 / Pack
823401	210	297	Portrait	No heavy load	1 / Pack
823405	297	105	Portrait	No heavy load	1 / Pack
823402	297	420	Portrait	No heavy load	1 / Pack
Aluminium					
823411	150	50	Landscape	No heavy load	1 / Pack
823413	450	150	Landscape	No heavy load	1 / Pack
823408	148	210	Portrait	No heavy load	1 / Pack
823409	210	297	Portrait	No heavy load	1 / Pack
823412	297	105	Portrait	No heavy load	1 / Pack
823410	297	420	Portrait	No heavy load	1 / Pack
Laminated Polyester					
823395	150	50	Landscape	No heavy load	1 / Pack
823396	297	74	Landscape	No heavy load	1 / Pack
823398	450	150	Landscape	No heavy load	1 / Pack
823399	600	200	Landscape	No heavy load	1 / Pack
823392	148	210	Portrait	No heavy load	1 / Pack
823393	210	297	Portrait	No heavy load	1 / Pack
823397	297	105	Portrait	No heavy load	1 / Pack
823394	297	420	Portrait	No heavy load	1 / Pack



PHOTOLUMINESCENT SIGNS

Order Ref.	Diameter (mm)	Class	Total Qty/Pack
Class B Photoluminescent Polyester			
835946	150	Class B	1 / Pack
Class C Photoluminescent Polyester			
835952	150	Class C	1 / Pack
Class B Photoluminescent Polypropylene			
835944	150	Class B	1 / Pack
Class C Photoluminescent Polypropylene			
835945	150	Class C	1 / Pack
Class C Photoluminescent Aluminium			
835943	150	Class C	1 / Pack

i For all material properties and applications, see pages 4-5

BRADY Customise-it See page 196 to order your custom-made signs.



P013 : No ACTIVATED MOBILE PHONES

While mobile phones are omnipresent in everyone's daily life, using them may be prohibited in certain environments for various reasons.



SIGNS

Order Ref.	Diameter (mm)	Total Qty/ Pack
Laminated Polyester		
823484	50	2 / Pack
823486	100	1 / Pack
823487	200	1 / Pack
823488	315	1 / Pack
Polypropylene		
823490	100	1 / Pack
823491	200	1 / Pack
823492	315	1 / Pack
Aluminium		
823494	100	1 / Pack
823495	200	1 / Pack
823496	315	1 / Pack

FLOOR MARKING

Order Ref.	Diameter (mm)	Total Qty/ Pack
Anti-skid Laminated Polyester		
823489	500	1 / Pack

MINI-PICTOGRAMS

Order Ref.	Diameter (mm)	Total Qty/ Pack
Laminated Polyester		
823482	25	7 / Pack
Vinyl		
823480	15	54 / Pack

SIGNS WITH TEXT



Order Ref.	Width (mm)	Height (mm)	Layout	Legend	Total Qty/ Pack
Polypropylene					
823552	150	50	Landscape	No activated mobile phones	1 / Pack
823553	297	74	Landscape	No activated mobile phones	1 / Pack
823555	450	150	Landscape	No activated mobile phones	1 / Pack
823556	600	200	Landscape	No activated mobile phones	1 / Pack
823549	148	210	Portrait	No activated mobile phones	1 / Pack
823550	210	297	Portrait	No activated mobile phones	1 / Pack
823554	297	105	Portrait	No activated mobile phones	1 / Pack
823551	297	420	Portrait	No activated mobile phones	1 / Pack
Aluminium					
823560	150	50	Landscape	No activated mobile phones	1 / Pack
823562	450	150	Landscape	No activated mobile phones	1 / Pack
823557	148	210	Portrait	No activated mobile phones	1 / Pack
823558	210	297	Portrait	No activated mobile phones	1 / Pack
823561	297	105	Portrait	No activated mobile phones	1 / Pack
823559	297	420	Portrait	No activated mobile phones	1 / Pack
Laminated Polyester					
823544	150	50	Landscape	No activated mobile phones	1 / Pack
823545	297	74	Landscape	No activated mobile phones	1 / Pack
823547	450	150	Landscape	No activated mobile phones	1 / Pack
823548	600	200	Landscape	No activated mobile phones	1 / Pack
823541	148	210	Portrait	No activated mobile phones	1 / Pack
823542	210	297	Portrait	No activated mobile phones	1 / Pack
823546	297	105	Portrait	No activated mobile phones	1 / Pack
823543	297	420	Portrait	No activated mobile phones	1 / Pack



PICTOGRAMS ON ROLLS

Order Ref.	Diameter (mm)	Total Qty/Pack
Laminated Polyester		
823481	25	250 / Roll
823483	50	250 / Roll
823485	100	250 / Roll



PHOTOLUMINESCENT SIGNS

Order Ref.	Diameter (mm)	Class	Total Qty/ Pack
Class B Photoluminescent Polyester			
835979	150	Class B	1 / Pack
836762	200	Class B	1 / Pack
Class C Photoluminescent Polyester			
835980	150	Class C	1 / Pack
Class B Photoluminescent Polypropylene			
835969	150	Class B	1 / Pack
836760	200	Class B	1 / Pack
836761	300	Class B	1 / Pack
Class C Photoluminescent Polypropylene			
835977	150	Class C	1 / Pack
Class C Photoluminescent Aluminium			
835968	150	Class C	1 / Pack

i For all material properties and applications, see pages 4-5

BRADY Customise-it See page 196 to order your custom-made signs.

Complies with EN ISO 7010

P014 : No access for persons with metallic implants

For their safety, persons with metallic implants may be banned from accessing certain areas. Pointing this out is therefore vital.



SIGNS

Order Ref.	Diameter (mm)	Total Qty/Pack
Laminated Polyester		
823633	50	2 / Pack
823635	100	1 / Pack
823636	200	1 / Pack
823637	315	1 / Pack
Polypropylene		
823639	100	1 / Pack
823640	200	1 / Pack
823641	315	1 / Pack
Aluminium		
823643	100	1 / Pack
823644	200	1 / Pack
823645	315	1 / Pack

FLOOR MARKING

Order Ref.	Diameter (mm)	Total Qty/Pack
Anti-skid Laminated Polyester		
823638	500	1 / Pack

MINI-PICTOGRAMS

Order Ref.	Diameter (mm)	Total Qty/Pack
Laminated Polyester		
823631	25	7 / Pack
Vinyl		
823629	15	54 / Pack



PICTOGRAMS ON ROLLS

Order Ref.	Diameter (mm)	Total Qty/Pack
Laminated Polyester		
823630	25	250 / Roll
823632	50	250 / Roll
823634	100	250 / Roll



PHOTOLUMINESCENT SIGNS

Order Ref.	Diameter (mm)	Class	Total Qty/Pack
Class B Photoluminescent Polyester			
835985	150	Class B	1 / Pack
Class C Photoluminescent Polyester			
835986	150	Class C	1 / Pack
Class B Photoluminescent Polypropylene			
835982	150	Class B	1 / Pack
Class C Photoluminescent Polypropylene			
835984	150	Class C	1 / Pack
Class C Photoluminescent Aluminium			
835981	150	Class C	1 / Pack

SIGNS WITH TEXT



Order Ref.	Width (mm)	Height (mm)	Layout	Legend	Total Qty/Pack
Polypropylene					
823701	150	50	Landscape	No access for persons with metallic implants	1 / Pack
823702	297	74	Landscape	No access for persons with metallic implants	1 / Pack
823704	450	150	Landscape	No access for persons with metallic implants	1 / Pack
823705	600	200	Landscape	No access for persons with metallic implants	1 / Pack
823698	148	210	Portrait	No access for persons with metallic implants	1 / Pack
823699	210	297	Portrait	No access for persons with metallic implants	1 / Pack
823703	297	105	Portrait	No access for persons with metallic implants	1 / Pack
823700	297	420	Portrait	No access for persons with metallic implants	1 / Pack
Aluminium					
823709	150	50	Landscape	No access for persons with metallic implants	1 / Pack
823711	450	150	Landscape	No access for persons with metallic implants	1 / Pack
823706	148	210	Portrait	No access for persons with metallic implants	1 / Pack
823707	210	297	Portrait	No access for persons with metallic implants	1 / Pack
823710	297	105	Portrait	No access for persons with metallic implants	1 / Pack
823708	297	420	Portrait	No access for persons with metallic implants	1 / Pack
Laminated Polyester					
823693	150	50	Landscape	No access for persons with metallic implants	1 / Pack
823694	297	74	Landscape	No access for persons with metallic implants	1 / Pack
823696	450	150	Landscape	No access for persons with metallic implants	1 / Pack
823697	600	200	Landscape	No access for persons with metallic implants	1 / Pack
823690	148	210	Portrait	No access for persons with metallic implants	1 / Pack
823691	210	297	Portrait	No access for persons with metallic implants	1 / Pack
823695	297	105	Portrait	No access for persons with metallic implants	1 / Pack
823692	297	420	Portrait	No access for persons with metallic implants	1 / Pack

i For all material properties and applications, see pages 4-5

BRADY Customise-it See page 196 to order your custom-made signs.



P015 : No REACHING IN

To avoid an accident, indicating in specific locations that hands must be kept clear may be important.



SIGNS

Order Ref.	Diameter (mm)	Total Qty/Pack
Laminated Polyester		
823782	50	2 / Pack
823784	100	1 / Pack
823785	200	1 / Pack
823786	315	1 / Pack
Polypropylene		
823788	100	1 / Pack
823789	200	1 / Pack
823790	315	1 / Pack
Aluminium		
823792	100	1 / Pack
823793	200	1 / Pack
823794	315	1 / Pack

FLOOR MARKING

Order Ref.	Diameter (mm)	Total Qty/Pack
Anti-skid Laminated Polyester		
823787	500	1 / Pack

MINI-PICTOGRAMS

Order Ref.	Diameter (mm)	Total Qty/Pack
Laminated Polyester		
138984	10	54 / Pack
823780	25	7 / Pack
138985	30	15 / Pack
Vinyl		
823778	15	54 / Pack

SIGNS WITH TEXT



Order Ref.	Width (mm)	Height (mm)	Layout	Legend	Total Qty/Pack
Polypropylene					
823850	150	50	Landscape	No reaching in	1 / Pack
823851	297	74	Landscape	No reaching in	1 / Pack
823853	450	150	Landscape	No reaching in	1 / Pack
823854	600	200	Landscape	No reaching in	1 / Pack
823847	148	210	Portrait	No reaching in	1 / Pack
823848	210	297	Portrait	No reaching in	1 / Pack
823852	297	105	Portrait	No reaching in	1 / Pack
823849	297	420	Portrait	No reaching in	1 / Pack
Aluminium					
823858	150	50	Landscape	No reaching in	1 / Pack
823860	450	150	Landscape	No reaching in	1 / Pack
823855	148	210	Portrait	No reaching in	1 / Pack
823856	210	297	Portrait	No reaching in	1 / Pack
823859	297	105	Portrait	No reaching in	1 / Pack
823857	297	420	Portrait	No reaching in	1 / Pack
Laminated Polyester					
823842	150	50	Landscape	No reaching in	1 / Pack
823843	297	74	Landscape	No reaching in	1 / Pack
823845	450	150	Landscape	No reaching in	1 / Pack
823846	600	200	Landscape	No reaching in	1 / Pack
823839	148	210	Portrait	No reaching in	1 / Pack
823840	210	297	Portrait	No reaching in	1 / Pack
823844	297	105	Portrait	No reaching in	1 / Pack
823841	297	420	Portrait	No reaching in	1 / Pack



PICTOGRAMS ON ROLLS

Order Ref.	Diameter (mm)	Total Qty/Pack
Laminated Polyester		
823779	25	250 / Roll
823781	50	250 / Roll
823783	100	250 / Roll



PHOTOLUMINESCENT SIGNS

Order Ref.	Diameter (mm)	Class	Total Qty/Pack
Class B Photoluminescent Polyester			
835994	150	Class B	1 / Pack
Class C Photoluminescent Polyester			
835995	150	Class C	1 / Pack
Class B Photoluminescent Polypropylene			
835988	150	Class B	1 / Pack
Class C Photoluminescent Polypropylene			
835992	150	Class C	1 / Pack
Class C Photoluminescent Aluminium			
835987	150	Class C	1 / Pack

i For all material properties and applications, see pages 4-5

BRADY Customise-it See page 196 to order your custom-made signs.

Complies with EN ISO 7010

P016 : Do NOT SPRAY WITH WATER

To avoid any damage, spraying some components with water may be prohibited.



SIGNS

Order Ref.	Diameter (mm)	Total Qty/Pack
Laminated Polyester		
831087	50	2 / Pack
831089	100	1 / Pack
831090	200	1 / Pack
831091	315	1 / Pack
Polypropylene		
831093	100	1 / Pack
831094	200	1 / Pack
831095	315	1 / Pack
831096	400	1 / Pack
Aluminium		
831097	100	1 / Pack
831098	200	1 / Pack
831099	315	1 / Pack

FLOOR MARKING

Order Ref.	Diameter (mm)	Total Qty/Pack
Anti-skid Laminated Polyester		
831092	500	1 / Pack

MINI-PICTOGRAMS

Order Ref.	Diameter (mm)	Total Qty/Pack
Laminated Polyester		
138981	20	18 / Pack
831085	25	7 / Pack
Vinyl		
831083	15	54 / Pack

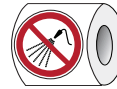

PICTOGRAMS ON ROLLS

Order Ref.	Diameter (mm)	Total Qty/Pack
Laminated Polyester		
831084	25	250 / Roll
831086	50	250 / Roll
831088	100	250 / Roll



PHOTOLUMINESCENT SIGNS

Order Ref.	Diameter (mm)	Class	Total Qty/Pack
Class B Photoluminescent Polyester			
835999	150	Class B	1 / Pack
Class C Photoluminescent Polyester			
836011	150	Class C	1 / Pack
Class B Photoluminescent Polypropylene			
835997	150	Class B	1 / Pack
Class C Photoluminescent Polypropylene			
835998	150	Class C	1 / Pack
Class C Photoluminescent Aluminium			
835996	150	Class C	1 / Pack

i For all material properties and applications, see pages 4-5

BRADY Customise-it See page 196 to order your custom-made signs.

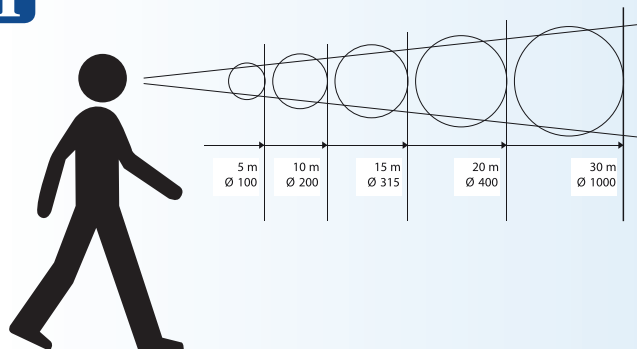

READING DISTANCE

Sign sizes depend on reading distance. The diagram opposite allows you to ensure that dimensions of a pictogram meet European Directives as closely as possible. Photoluminescent signs must be used where natural lighting is inadequate (especially to mark exits and emergency exits).



P017 : No PUSHING

Faced with a fragile structure, it is sometimes important to point out that pushing is banned.



SIGNS

Order Ref.	Diameter (mm)	Total Qty/Pack
Laminated Polyester		
823931	50	2 / Pack
823933	100	1 / Pack
823934	200	1 / Pack
823935	315	1 / Pack
Polypropylene		
823937	100	1 / Pack
823938	200	1 / Pack
823939	315	1 / Pack
Aluminium		
823941	100	1 / Pack
823942	200	1 / Pack
823943	315	1 / Pack

FLOOR MARKING

Order Ref.	Diameter (mm)	Total Qty/Pack
Anti-skid Laminated Polyester		
823936	500	1 / Pack

MINI-PICTOGRAMS

Order Ref.	Diameter (mm)	Total Qty/Pack
Laminated Polyester		
138986	20	18 / Pack
823929	25	7 / Pack
Vinyl		
823927	15	54 / Pack

SIGNS WITH TEXT



Order Ref.	Width (mm)	Height (mm)	Layout	Legend	Total Qty/Pack
Polypropylene					
823999	150	50	Landscape	No pushing	1 / Pack
824000	297	74	Landscape	No pushing	1 / Pack
824002	450	150	Landscape	No pushing	1 / Pack
824003	600	200	Landscape	No pushing	1 / Pack
823996	148	210	Portrait	No pushing	1 / Pack
823997	210	297	Portrait	No pushing	1 / Pack
824001	297	105	Portrait	No pushing	1 / Pack
823998	297	420	Portrait	No pushing	1 / Pack
Aluminium					
824007	150	50	Landscape	No pushing	1 / Pack
824009	450	150	Landscape	No pushing	1 / Pack
824004	148	210	Portrait	No pushing	1 / Pack
824005	210	297	Portrait	No pushing	1 / Pack
824008	297	105	Portrait	No pushing	1 / Pack
824006	297	420	Portrait	No pushing	1 / Pack
Laminated Polyester					
823991	150	50	Landscape	No pushing	1 / Pack
823992	297	74	Landscape	No pushing	1 / Pack
823994	450	150	Landscape	No pushing	1 / Pack
823995	600	200	Landscape	No pushing	1 / Pack
823988	148	210	Portrait	No pushing	1 / Pack
823989	210	297	Portrait	No pushing	1 / Pack
823993	297	105	Portrait	No pushing	1 / Pack
823990	297	420	Portrait	No pushing	1 / Pack



PICTOGRAMS ON ROLLS

Order Ref.	Diameter (mm)	Total Qty/Pack
Laminated Polyester		
823928	25	250 / Roll
823930	50	250 / Roll
823932	100	250 / Roll



PHOTOLUMINESCENT SIGNS

Order Ref.	Diameter (mm)	Class	Total Qty/Pack
Class B Photoluminescent Polyester			
836023	150	Class B	1 / Pack
Class C Photoluminescent Polyester			
836024	150	Class C	1 / Pack
Class B Photoluminescent Polypropylene			
836016	150	Class B	1 / Pack
Class C Photoluminescent Polypropylene			
836022	150	Class C	1 / Pack
Class C Photoluminescent Aluminium			
836013	150	Class C	1 / Pack

i For all material properties and applications, see pages 4-5

BRADY Customise-it See page 196 to order your custom-made signs.

Complies with EN ISO 7010

P018 : No SITTING

As much to avoid damage as to avoid an injury, specifying that sitting down is prohibited may be necessary.



SIGNS

Order Ref.	Diameter (mm)	Total Qty/Pack
Laminated Polyester		
824080	50	2 / Pack
824082	100	1 / Pack
824083	200	1 / Pack
824084	315	1 / Pack
Polypropylene		
824086	100	1 / Pack
824087	200	1 / Pack
824088	315	1 / Pack
Aluminium		
824090	100	1 / Pack
824091	200	1 / Pack
824092	315	1 / Pack

FLOOR MARKING

Order Ref.	Diameter (mm)	Total Qty/Pack
Anti-skid Laminated Polyester		
824085	500	1 / Pack

MINI-PICTOGRAMS

Order Ref.	Diameter (mm)	Total Qty/Pack
Laminated Polyester		
824078	25	7 / Pack
Vinyl		
824076	15	54 / Pack



PICTOGRAMS ON ROLLS

Order Ref.	Diameter (mm)	Total Qty/Pack
Laminated Polyester		
824077	25	250 / Roll
824079	50	250 / Roll
824081	100	250 / Roll

SIGNS WITH TEXT



Order Ref.	Width (mm)	Height (mm)	Layout	Legend	Total Qty/Pack
Polypropylene					
824148	150	50	Landscape	No sitting	1 / Pack
824149	297	74	Landscape	No sitting	1 / Pack
824151	450	150	Landscape	No sitting	1 / Pack
824152	600	200	Landscape	No sitting	1 / Pack
824145	148	210	Portrait	No sitting	1 / Pack
824146	210	297	Portrait	No sitting	1 / Pack
824150	297	105	Portrait	No sitting	1 / Pack
824147	297	420	Portrait	No sitting	1 / Pack
Aluminium					
824156	150	50	Landscape	No sitting	1 / Pack
824158	450	150	Landscape	No sitting	1 / Pack
824153	148	210	Portrait	No sitting	1 / Pack
824154	210	297	Portrait	No sitting	1 / Pack
824157	297	105	Portrait	No sitting	1 / Pack
824155	297	420	Portrait	No sitting	1 / Pack
Laminated Polyester					
824140	150	50	Landscape	No sitting	1 / Pack
824141	297	74	Landscape	No sitting	1 / Pack
824143	450	150	Landscape	No sitting	1 / Pack
824144	600	200	Landscape	No sitting	1 / Pack
824137	148	210	Portrait	No sitting	1 / Pack
824138	210	297	Portrait	No sitting	1 / Pack
824142	297	105	Portrait	No sitting	1 / Pack
824139	297	420	Portrait	No sitting	1 / Pack



PHOTOLUMINESCENT SIGNS

Order Ref.	Diameter (mm)	Class	Total Qty/Pack
Class B Photoluminescent Polyester			
836028	150	Class B	1 / Pack
Class C Photoluminescent Polyester			
836029	150	Class C	1 / Pack
Class B Photoluminescent Polypropylene			
836026	150	Class B	1 / Pack
Class C Photoluminescent Polypropylene			
836027	150	Class C	1 / Pack
Class C Photoluminescent Aluminium			
836025	150	Class C	1 / Pack

i For all material properties and applications, see pages 4-5

BRADY Customise-it See page 196 to order your custom-made signs.



P019 : No STEPPING ON SURFACE

In the case of a fragile structure or sometimes when carrying out work, specifying a ban on walking on this surface may be necessary.



SIGNS

Order Ref.	Diameter (mm)	Total Qty/Pack
Laminated Polyester		
824229	50	2 / Pack
824231	100	1 / Pack
824232	200	1 / Pack
824233	315	1 / Pack
Polypropylene		
824235	100	1 / Pack
824236	200	1 / Pack
824237	315	1 / Pack
Aluminium		
824239	100	1 / Pack
824240	200	1 / Pack
824241	315	1 / Pack

FLOOR MARKING

Order Ref.	Diameter (mm)	Total Qty/Pack
Anti-skid Laminated Polyester		
824234	500	1 / Pack

MINI-PICTOGRAMS

Order Ref.	Diameter (mm)	Total Qty/Pack
Laminated Polyester		
824227	25	7 / Pack
Vinyl		
824225	15	54 / Pack

SIGNS WITH TEXT



Order Ref.	Width (mm)	Height (mm)	Layout	Legend	Total Qty/Pack
Polypropylene					
824297	150	50	Landscape	No stepping on surface	1 / Pack
824298	297	74	Landscape	No stepping on surface	1 / Pack
824300	450	150	Landscape	No stepping on surface	1 / Pack
824301	600	200	Landscape	No stepping on surface	1 / Pack
824294	148	210	Portrait	No stepping on surface	1 / Pack
824295	210	297	Portrait	No stepping on surface	1 / Pack
824299	297	105	Portrait	No stepping on surface	1 / Pack
824296	297	420	Portrait	No stepping on surface	1 / Pack
Aluminium					
824305	150	50	Landscape	No stepping on surface	1 / Pack
824307	450	150	Landscape	No stepping on surface	1 / Pack
824302	148	210	Portrait	No stepping on surface	1 / Pack
824303	210	297	Portrait	No stepping on surface	1 / Pack
824306	297	105	Portrait	No stepping on surface	1 / Pack
824304	297	420	Portrait	No stepping on surface	1 / Pack
Laminated Polyester					
824289	150	50	Landscape	No stepping on surface	1 / Pack
824290	297	74	Landscape	No stepping on surface	1 / Pack
824292	450	150	Landscape	No stepping on surface	1 / Pack
824293	600	200	Landscape	No stepping on surface	1 / Pack
824286	148	210	Portrait	No stepping on surface	1 / Pack
824287	210	297	Portrait	No stepping on surface	1 / Pack
824291	297	105	Portrait	No stepping on surface	1 / Pack
824288	297	420	Portrait	No stepping on surface	1 / Pack



PICTOGRAMS ON ROLLS

Order Ref.	Diameter (mm)	Total Qty/Pack
Laminated Polyester		
824226	25	250 / Roll
824228	50	250 / Roll
824230	100	250 / Roll



PHOTOLUMINESCENT SIGNS

Order Ref.	Diameter (mm)	Class	Total Qty/Pack
Class B Photoluminescent Polyester			
836033	150	Class B	1 / Pack
Class C Photoluminescent Polyester			
836034	150	Class C	1 / Pack
Class B Photoluminescent Polypropylene			
836031	150	Class B	1 / Pack
Class C Photoluminescent Polypropylene			
836032	150	Class C	1 / Pack
Class C Photoluminescent Aluminium			
836030	150	Class C	1 / Pack

i For all material properties and applications, see pages 4-5

BRADY Customise-it See page 196 to order your custom-made signs.

Complies with EN ISO 7010

P020 : Do NOT USE LIFT IN THE EVENT OF FIRE

Taking a lift in the event of a fire can be extremely dangerous, this ban must therefore be made very visible to avoid people becoming trapped inside.



SIGNS

Order Ref.	Diameter (mm)	Total Qty/Pack
Laminated Polyester		
824378	50	2 / Pack
824380	100	1 / Pack
824381	200	1 / Pack
824382	315	1 / Pack
Polypropylene		
824384	100	1 / Pack
824385	200	1 / Pack
824386	315	1 / Pack
Aluminium		
824388	100	1 / Pack
824389	200	1 / Pack
824390	315	1 / Pack

FLOOR MARKING

Order Ref.	Diameter (mm)	Total Qty/Pack
Anti-skid Laminated Polyester		
824383	500	1 / Pack

MINI-PICTOGRAMS

Order Ref.	Diameter (mm)	Total Qty/Pack
Laminated Polyester		
824376	25	7 / Pack
Vinyl		
824374	15	54 / Pack



PICTOGRAMS ON ROLLS

Order Ref.	Diameter (mm)	Total Qty/Pack
Laminated Polyester		
824375	25	250 / Roll
824377	50	250 / Roll
824379	100	250 / Roll



PHOTOLUMINESCENT SIGNS WITH TEXT

Order Ref.	Width (mm)	Height (mm)	Class	Legend	Total Qty/Pack
Class B Photoluminescent Polyester					
836039	300	300	Class B	In the event of fire do not use this lift	1 / Pack
836038	250	100	Class B	In the event of fire do not use this lift	1 / Pack
Class B Photoluminescent Polypropylene					
836037	300	300	Class B	In the event of fire do not use this lift	1 / Pack
836036	250	100	Class B	In the event of fire do not use this lift	1 / Pack
Class C Photoluminescent Aluminium					
836035	100	100	Class C	In the event of fire do not use this lift	1 / Pack

SIGNS WITH TEXT



Order Ref.	Width (mm)	Height (mm)	Layout	Legend	Total Qty/Pack
Polypropylene					
824446	150	50	Landscape	Do not use lift in the event of fire	1 / Pack
824447	297	74	Landscape	Do not use lift in the event of fire	1 / Pack
824449	450	150	Landscape	Do not use lift in the event of fire	1 / Pack
824450	600	200	Landscape	Do not use lift in the event of fire	1 / Pack
824443	148	210	Portrait	Do not use lift in the event of fire	1 / Pack
824444	210	297	Portrait	Do not use lift in the event of fire	1 / Pack
824448	297	105	Portrait	Do not use lift in the event of fire	1 / Pack
824445	297	420	Portrait	Do not use lift in the event of fire	1 / Pack
Aluminium					
824454	150	50	Landscape	Do not use lift in the event of fire	1 / Pack
824456	450	150	Landscape	Do not use lift in the event of fire	1 / Pack
824451	148	210	Portrait	Do not use lift in the event of fire	1 / Pack
824452	210	297	Portrait	Do not use lift in the event of fire	1 / Pack
824455	297	105	Portrait	Do not use lift in the event of fire	1 / Pack
824453	297	420	Portrait	Do not use lift in the event of fire	1 / Pack
Laminated Polyester					
824438	150	50	Landscape	Do not use lift in the event of fire	1 / Pack
824439	297	74	Landscape	Do not use lift in the event of fire	1 / Pack
824441	450	150	Landscape	Do not use lift in the event of fire	1 / Pack
824442	600	200	Landscape	Do not use lift in the event of fire	1 / Pack
824435	148	210	Portrait	Do not use lift in the event of fire	1 / Pack
824436	210	297	Portrait	Do not use lift in the event of fire	1 / Pack
824440	297	105	Portrait	Do not use lift in the event of fire	1 / Pack
824437	297	420	Portrait	Do not use lift in the event of fire	1 / Pack

i For all material properties and applications, see pages 4-5

BRADY Customise-it See page 196 to order your custom-made signs.



P021 : No dogs

Dogs may be prohibited in certain places, this symbol therefore clarifies this ban. However, guide dogs or service dogs are often exempt from this ban. It is therefore appreciated if this is indicated.



SIGNS

Order Ref.	Diameter (mm)	Total Qty/Pack
Laminated Polyester		
824527	50	2 / Pack
824529	100	1 / Pack
824530	200	1 / Pack
824531	315	1 / Pack
Polypropylene		
824533	100	1 / Pack
824534	200	1 / Pack
824535	315	1 / Pack
824536	400	1 / Pack
Aluminium		
824537	100	1 / Pack
824538	200	1 / Pack
824539	315	1 / Pack

FLOOR MARKING

Order Ref.	Diameter (mm)	Total Qty/Pack
Anti-skid Laminated Polyester		
824532	500	1 / Pack

MINI-PICTOGRAMS

Order Ref.	Diameter (mm)	Total Qty/Pack
Laminated Polyester		
824525	25	7 / Pack
Vinyl		
824523	15	54 / Pack



PICTOGRAMS ON ROLLS

Order Ref.	Diameter (mm)	Total Qty/Pack
Laminated Polyester		
824524	25	250 / Roll
824526	50	250 / Roll
824528	100	250 / Roll

SIGNS WITH TEXT



Order Ref.	Width (mm)	Height (mm)	Layout	Legend	Total Qty/Pack
Polypropylene					
824595	150	50	Landscape	No dogs	1 / Pack
824596	297	74	Landscape	No dogs	1 / Pack
824598	450	150	Landscape	No dogs	1 / Pack
824599	600	200	Landscape	No dogs	1 / Pack
824592	148	210	Portrait	No dogs	1 / Pack
824593	210	297	Portrait	No dogs	1 / Pack
824597	297	105	Portrait	No dogs	1 / Pack
824594	297	420	Portrait	No dogs	1 / Pack
Aluminium					
824603	150	50	Landscape	No dogs	1 / Pack
824605	450	150	Landscape	No dogs	1 / Pack
824600	148	210	Portrait	No dogs	1 / Pack
824601	210	297	Portrait	No dogs	1 / Pack
824604	297	105	Portrait	No dogs	1 / Pack
824602	297	420	Portrait	No dogs	1 / Pack
Laminated Polyester					
824587	150	50	Landscape	No dogs	1 / Pack
824588	297	74	Landscape	No dogs	1 / Pack
824590	450	150	Landscape	No dogs	1 / Pack
824591	600	200	Landscape	No dogs	1 / Pack
824584	148	210	Portrait	No dogs	1 / Pack
824585	210	297	Portrait	No dogs	1 / Pack
824589	297	105	Portrait	No dogs	1 / Pack
824586	297	420	Portrait	No dogs	1 / Pack



PHOTOLUMINESCENT SIGNS

Order Ref.	Diameter (mm)	Class	Total Qty/Pack
Class B Photoluminescent Polyester			
836044	150	Class B	1 / Pack
Class C Photoluminescent Polyester			
836045	150	Class C	1 / Pack
Class B Photoluminescent Polypropylene			
836042	150	Class B	1 / Pack
Class C Photoluminescent Polypropylene			
836043	150	Class C	1 / Pack
Class C Photoluminescent Aluminium			
836041	150	Class C	1 / Pack

Complies with EN ISO 7010

P022 : No EATING OR DRINKING

Eating or drinking in certain places may be prohibited. This must therefore be clearly indicated.



SIGNS

Order Ref.	Diameter (mm)	Total Qty/Pack
Laminated Polyester		
824676	50	2 / Pack
824678	100	1 / Pack
824679	200	1 / Pack
824680	315	1 / Pack
Polypropylene		
824682	100	1 / Pack
824683	200	1 / Pack
824684	315	1 / Pack
Aluminium		
824686	100	1 / Pack
824687	200	1 / Pack
824688	315	1 / Pack

FLOOR MARKING

Order Ref.	Diameter (mm)	Total Qty/Pack
Anti-skid Laminated Polyester		
824681	500	1 / Pack

MINI-PICTOGRAMS

Order Ref.	Diameter (mm)	Total Qty/Pack
Laminated Polyester		
824674	25	7 / Pack
Vinyl		
824672	15	54 / Pack



SIGNS WITH TEXT



Order Ref.	Width (mm)	Height (mm)	Layout	Legend	Total Qty/Pack
Polypropylene					
824744	150	50	Landscape	No eating or drinking	1 / Pack
824745	297	74	Landscape	No eating or drinking	1 / Pack
824747	450	150	Landscape	No eating or drinking	1 / Pack
824748	600	200	Landscape	No eating or drinking	1 / Pack
824741	148	210	Portrait	No eating or drinking	1 / Pack
824742	210	297	Portrait	No eating or drinking	1 / Pack
824746	297	105	Portrait	No eating or drinking	1 / Pack
824743	297	420	Portrait	No eating or drinking	1 / Pack
Aluminium					
824752	150	50	Landscape	No eating or drinking	1 / Pack
824754	450	150	Landscape	No eating or drinking	1 / Pack
824749	148	210	Portrait	No eating or drinking	1 / Pack
824750	210	297	Portrait	No eating or drinking	1 / Pack
824753	297	105	Portrait	No eating or drinking	1 / Pack
824751	297	420	Portrait	No eating or drinking	1 / Pack
Laminated Polyester					
824736	150	50	Landscape	No eating or drinking	1 / Pack
824737	297	74	Landscape	No eating or drinking	1 / Pack
824739	450	150	Landscape	No eating or drinking	1 / Pack
824740	600	200	Landscape	No eating or drinking	1 / Pack
824733	148	210	Portrait	No eating or drinking	1 / Pack
824734	210	297	Portrait	No eating or drinking	1 / Pack
824738	297	105	Portrait	No eating or drinking	1 / Pack
824735	297	420	Portrait	No eating or drinking	1 / Pack



PICTOGRAMS ON ROLLS

Order Ref.	Diameter (mm)	Total Qty/Pack
Laminated Polyester		
824673	25	250 / Roll
824675	50	250 / Roll
824677	100	250 / Roll



PHOTOLUMINESCENT SIGNS

Order Ref.	Diameter (mm)	Class	Total Qty/Pack
Class B Photoluminescent Polyester			
836051	150	Class B	1 / Pack
Class C Photoluminescent Polyester			
836053	150	Class C	1 / Pack
Class B Photoluminescent Polypropylene			
836049	150	Class B	1 / Pack
Class C Photoluminescent Polypropylene			
836050	150	Class C	1 / Pack
Class C Photoluminescent Aluminium			
836048	150	Class C	1 / Pack

i For all material properties and applications, see pages 4-5

BRADY Customise-it See page 196 to order your custom-made signs.

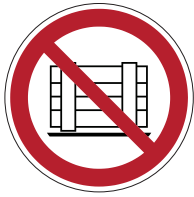

P023 : Do NOT OBSTRUCT

Not obstructing certain zones allows an emergency exit to be left clear.



SIGNS

Order Ref.	Diameter (mm)	Total Qty/Pack
Laminated Polyester		
824825	50	2 / Pack
824827	100	1 / Pack
824828	200	1 / Pack
824829	315	1 / Pack
Polypropylene		
824831	100	1 / Pack
824832	200	1 / Pack
824833	315	1 / Pack
Aluminium		
824835	100	1 / Pack
824836	200	1 / Pack
824837	315	1 / Pack

FLOOR MARKING

Order Ref.	Diameter (mm)	Total Qty/Pack
Anti-skid Laminated Polyester		
824830	500	1 / Pack

MINI-PICTOGRAMS

Order Ref.	Diameter (mm)	Total Qty/Pack
Laminated Polyester		
824823	25	7 / Pack
Vinyl		
824821	15	54 / Pack

SIGNS WITH TEXT



Order Ref.	Width (mm)	Height (mm)	Layout	Legend	Total Qty/Pack
Polypropylene					
824893	150	50	Landscape	Do not obstruct	1 / Pack
824894	297	74	Landscape	Do not obstruct	1 / Pack
824896	450	150	Landscape	Do not obstruct	1 / Pack
824897	600	200	Landscape	Do not obstruct	1 / Pack
824890	148	210	Portrait	Do not obstruct	1 / Pack
824891	210	297	Portrait	Do not obstruct	1 / Pack
824895	297	105	Portrait	Do not obstruct	1 / Pack
824892	297	420	Portrait	Do not obstruct	1 / Pack
Aluminium					
824901	150	50	Landscape	Do not obstruct	1 / Pack
824903	450	150	Landscape	Do not obstruct	1 / Pack
824898	148	210	Portrait	Do not obstruct	1 / Pack
824899	210	297	Portrait	Do not obstruct	1 / Pack
824902	297	105	Portrait	Do not obstruct	1 / Pack
824900	297	420	Portrait	Do not obstruct	1 / Pack
Laminated Polyester					
824885	150	50	Landscape	Do not obstruct	1 / Pack
824886	297	74	Landscape	Do not obstruct	1 / Pack
824888	450	150	Landscape	Do not obstruct	1 / Pack
824889	600	200	Landscape	Do not obstruct	1 / Pack
824882	148	210	Portrait	Do not obstruct	1 / Pack
824883	210	297	Portrait	Do not obstruct	1 / Pack
824887	297	105	Portrait	Do not obstruct	1 / Pack
824884	297	420	Portrait	Do not obstruct	1 / Pack



PICTOGRAMS ON ROLLS

Order Ref.	Diameter (mm)	Total Qty/Pack
Laminated Polyester		
824822	25	250 / Roll
824824	50	250 / Roll
824826	100	250 / Roll



PHOTOLUMINESCENT SIGNS

Order Ref.	Diameter (mm)	Class	Total Qty/Pack
Class B Photoluminescent Polyester			
836057	150	Class B	1 / Pack
Class C Photoluminescent Polyester			
836058	150	Class C	1 / Pack
Class B Photoluminescent Polypropylene			
836055	150	Class B	1 / Pack
Class C Photoluminescent Polypropylene			
836056	150	Class C	1 / Pack
Class C Photoluminescent Aluminium			
836054	150	Class C	1 / Pack

i For all material properties and applications, see pages 4-5

BRADY Customise-it See page 196 to order your custom-made signs.

Complies with EN ISO 7010

P024 : Do NOT WALK OR STAND HERE

Advising that walking and standing are prohibited may be important for the safety of pedestrians.



SIGNS

Order Ref.	Diameter (mm)	Total Qty/Pack
Laminated Polyester		
824974	50	2 / Pack
824976	100	1 / Pack
824977	200	1 / Pack
824978	315	1 / Pack
Polypropylene		
824980	100	1 / Pack
824981	200	1 / Pack
824982	315	1 / Pack
824983	400	1 / Pack
Aluminium		
824984	100	1 / Pack
824985	200	1 / Pack
824986	315	1 / Pack

FLOOR MARKING

Order Ref.	Diameter (mm)	Total Qty/Pack
Anti-skid Laminated Polyester		
824979	500	1 / Pack

MINI-PICTOGRAMS

Order Ref.	Diameter (mm)	Total Qty/Pack
Laminated Polyester		
824972	25	7 / Pack
Vinyl		
824970	15	54 / Pack

SIGNS WITH TEXT



Order Ref.	Width (mm)	Height (mm)	Layout	Legend	Total Qty/Pack
Polypropylene					
825042	150	50	Landscape	Do not walk or stand here	1 / Pack
825043	297	74	Landscape	Do not walk or stand here	1 / Pack
825045	450	150	Landscape	Do not walk or stand here	1 / Pack
825046	600	200	Landscape	Do not walk or stand here	1 / Pack
825039	148	210	Portrait	Do not walk or stand here	1 / Pack
825040	210	297	Portrait	Do not walk or stand here	1 / Pack
825044	297	105	Portrait	Do not walk or stand here	1 / Pack
825041	297	420	Portrait	Do not walk or stand here	1 / Pack
Aluminium					
825050	150	50	Landscape	Do not walk or stand here	1 / Pack
825052	450	150	Landscape	Do not walk or stand here	1 / Pack
825047	148	210	Portrait	Do not walk or stand here	1 / Pack
825048	210	297	Portrait	Do not walk or stand here	1 / Pack
825051	297	105	Portrait	Do not walk or stand here	1 / Pack
825049	297	420	Portrait	Do not walk or stand here	1 / Pack
Laminated Polyester					
825034	150	50	Landscape	Do not walk or stand here	1 / Pack
825035	297	74	Landscape	Do not walk or stand here	1 / Pack
825037	450	150	Landscape	Do not walk or stand here	1 / Pack
825038	600	200	Landscape	Do not walk or stand here	1 / Pack
825031	148	210	Portrait	Do not walk or stand here	1 / Pack
825032	210	297	Portrait	Do not walk or stand here	1 / Pack
825036	297	105	Portrait	Do not walk or stand here	1 / Pack
825033	297	420	Portrait	Do not walk or stand here	1 / Pack



PICTOGRAMS ON ROLLS

Order Ref.	Diameter (mm)	Total Qty/Pack
Laminated Polyester		
824971	25	250 / Roll
824973	50	250 / Roll
824975	100	250 / Roll



PHOTOLUMINESCENT SIGNS

Order Ref.	Diameter (mm)	Class	Total Qty/Pack
Class B Photoluminescent Polyester			
836063	150	Class B	1 / Pack
Class C Photoluminescent Polyester			
836064	150	Class C	1 / Pack
Class B Photoluminescent Polypropylene			
836061	150	Class B	1 / Pack
Class C Photoluminescent Polypropylene			
836062	150	Class C	1 / Pack
Class C Photoluminescent Aluminium			
836060	150	Class C	1 / Pack

i For all material properties and applications, see pages 4-5

BRADY Customise-it See page 196 to order your custom-made signs.



P025 : Do NOT USE THIS INCOMPLETE SCAFFOLD

When being erected, incomplete scaffolding can be dangerous. Indicating that it is incomplete is therefore important to avoid an accident.



SIGNS

Order Ref.	Diameter (mm)	Total Qty/Pack
Laminated Polyester		
825123	50	2 / Pack
825125	100	1 / Pack
825126	200	1 / Pack
825127	315	1 / Pack
Polypropylene		
825129	100	1 / Pack
825130	200	1 / Pack
825131	315	1 / Pack
Aluminium		
825133	100	1 / Pack
825134	200	1 / Pack
825135	315	1 / Pack

FLOOR MARKING

Order Ref.	Diameter (mm)	Total Qty/Pack
Anti-skid Laminated Polyester		
825128	500	1 / Pack

MINI-PICTOGRAMS

Order Ref.	Diameter (mm)	Total Qty/Pack
Laminated Polyester		
825121	25	7 / Pack
Vinyl		
825119	15	54 / Pack



PICTOGRAMS ON ROLLS

Order Ref.	Diameter (mm)	Total Qty/Pack
Laminated Polyester		
825120	25	250 / Roll
825122	50	250 / Roll
825124	100	250 / Roll



PHOTOLUMINESCENT SIGNS

Order Ref.	Diameter (mm)	Class	Total Qty/Pack
Class B Photoluminescent Polyester			
836068	150	Class B	1 / Pack
Class C Photoluminescent Polyester			
836069	150	Class C	1 / Pack
Class B Photoluminescent Polypropylene			
836066	150	Class B	1 / Pack
Class C Photoluminescent Polypropylene			
836067	150	Class C	1 / Pack
Class C Photoluminescent Aluminium			
836065	150	Class C	1 / Pack

SIGNS WITH TEXT

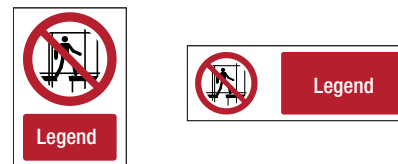

Order Ref.	Width (mm)	Height (mm)	Layout	Legend	Total Qty/Pack
Polypropylene					
825191	150	50	Landscape	Do not use this incomplete scaffold	1 / Pack
825192	297	74	Landscape	Do not use this incomplete scaffold	1 / Pack
825194	450	150	Landscape	Do not use this incomplete scaffold	1 / Pack
825195	600	200	Landscape	Do not use this incomplete scaffold	1 / Pack
825188	148	210	Portrait	Do not use this incomplete scaffold	1 / Pack
825189	210	297	Portrait	Do not use this incomplete scaffold	1 / Pack
825193	297	105	Portrait	Do not use this incomplete scaffold	1 / Pack
825190	297	420	Portrait	Do not use this incomplete scaffold	1 / Pack
Aluminium					
825199	150	50	Landscape	Do not use this incomplete scaffold	1 / Pack
825201	450	150	Landscape	Do not use this incomplete scaffold	1 / Pack
825196	148	210	Portrait	Do not use this incomplete scaffold	1 / Pack
825197	210	297	Portrait	Do not use this incomplete scaffold	1 / Pack
825200	297	105	Portrait	Do not use this incomplete scaffold	1 / Pack
825198	297	420	Portrait	Do not use this incomplete scaffold	1 / Pack
Laminated Polyester					
825183	150	50	Landscape	Do not use this incomplete scaffold	1 / Pack
825184	297	74	Landscape	Do not use this incomplete scaffold	1 / Pack
825186	450	150	Landscape	Do not use this incomplete scaffold	1 / Pack
825187	600	200	Landscape	Do not use this incomplete scaffold	1 / Pack
825180	148	210	Portrait	Do not use this incomplete scaffold	1 / Pack
825181	210	297	Portrait	Do not use this incomplete scaffold	1 / Pack
825185	297	105	Portrait	Do not use this incomplete scaffold	1 / Pack
825182	297	420	Portrait	Do not use this incomplete scaffold	1 / Pack

i For all material properties and applications, see pages 4-5

BRADY Customise-it See page 196 to order your custom-made signs.



Visual Tagging Solutions
Safety, Maintenance, Identification.

Communication of the status of an installation at any moment using the range of visual tagging. Contact your Brady distributor for more information.

Complies with EN ISO 7010

P026 : Do NOT USE THIS DEVICE IN A BATHTUB, SHOWER OR WATER-FILLED RESERVOIR

Some products, generally electric, must never be used in installations where there is contact with water. Specifying this can avoid an accident.



SIGNS

Order Ref.	Diameter (mm)	Total Qty/Pack
Laminated Polyester		
825272	50	2 / Pack
825274	100	1 / Pack
825275	200	1 / Pack
825276	315	1 / Pack
Polypropylene		
825278	100	1 / Pack
825279	200	1 / Pack
825280	315	1 / Pack
Aluminium		
825282	100	1 / Pack
825283	200	1 / Pack
825284	315	1 / Pack

FLOOR MARKING

Order Ref.	Diameter (mm)	Total Qty/Pack
Anti-skid Laminated Polyester		
825277	500	1 / Pack

MINI-PICTOGRAMS

Order Ref.	Diameter (mm)	Total Qty/Pack
Laminated Polyester		
825270	25	7 / Pack
Vinyl		
825268	15	54 / Pack



PICTOGRAMS ON ROLLS

Order Ref.	Diameter (mm)	Total Qty/Pack
Laminated Polyester		
825269	25	250 / Roll
825271	50	250 / Roll
825273	100	250 / Roll



PHOTOLUMINESCENT SIGNS

Order Ref.	Diameter (mm)	Class	Total Qty/Pack
Class B Photoluminescent Polyester			
836073	150	Class B	1 / Pack
Class C Photoluminescent Polyester			
836074	150	Class C	1 / Pack
Class B Photoluminescent Polypropylene			
836071	150	Class B	1 / Pack
Class C Photoluminescent Polypropylene			
836072	150	Class C	1 / Pack
Class C Photoluminescent Aluminium			
836070	150	Class C	1 / Pack

SIGNS WITH TEXT



Order Ref.	Width (mm)	Height (mm)	Layout	Legend	Total Qty/Pack
Polypropylene					
825340	150	50	Land-scape	Do not use this device in a bathtub, shower or water-filled reservoir	1 / Pack
825341	297	74	Land-scape	Do not use this device in a bathtub, shower or water-filled reservoir	1 / Pack
825343	450	150	Land-scape	Do not use this device in a bathtub, shower or water-filled reservoir	1 / Pack
825344	600	200	Land-scape	Do not use this device in a bathtub, shower or water-filled reservoir	1 / Pack
825337	148	210	Portrait	Do not use this device in a bathtub, shower or water-filled reservoir	1 / Pack
825338	210	297	Portrait	Do not use this device in a bathtub, shower or water-filled reservoir	1 / Pack
825342	297	105	Portrait	Do not use this device in a bathtub, shower or water-filled reservoir	1 / Pack
825339	297	420	Portrait	Do not use this device in a bathtub, shower or water-filled reservoir	1 / Pack
Aluminium					
825348	150	50	Land-scape	Do not use this device in a bathtub, shower or water-filled reservoir	1 / Pack
825350	450	150	Land-scape	Do not use this device in a bathtub, shower or water-filled reservoir	1 / Pack
825345	148	210	Portrait	Do not use this device in a bathtub, shower or water-filled reservoir	1 / Pack
825346	210	297	Portrait	Do not use this device in a bathtub, shower or water-filled reservoir	1 / Pack
825349	297	105	Portrait	Do not use this device in a bathtub, shower or water-filled reservoir	1 / Pack
825347	297	420	Portrait	Do not use this device in a bathtub, shower or water-filled reservoir	1 / Pack
Laminated Polyester					
825332	150	50	Land-scape	Do not use this device in a bathtub, shower or water-filled reservoir	1 / Pack
825333	297	74	Land-scape	Do not use this device in a bathtub, shower or water-filled reservoir	1 / Pack
825335	450	150	Land-scape	Do not use this device in a bathtub, shower or water-filled reservoir	1 / Pack
825336	600	200	Land-scape	Do not use this device in a bathtub, shower or water-filled reservoir	1 / Pack
825329	148	210	Portrait	Do not use this device in a bathtub, shower or water-filled reservoir	1 / Pack
825330	210	297	Portrait	Do not use this device in a bathtub, shower or water-filled reservoir	1 / Pack
825334	297	105	Portrait	Do not use this device in a bathtub, shower or water-filled reservoir	1 / Pack
825331	297	420	Portrait	Do not use this device in a bathtub, shower or water-filled reservoir	1 / Pack

i For all material properties and applications, see pages 4-5

BRADY Customise-it See page 196 to order your custom-made signs.



P027 : Do NOT USE THIS LIFT FOR PEOPLE

Some lifts are restricted to the transport of goods and cannot be used by people.



SIGNS

Order Ref.	Diameter (mm)	Total Qty/Pack
Laminated Polyester		
825421	50	2 / Pack
825423	100	1 / Pack
825424	200	1 / Pack
825425	315	1 / Pack
Polypropylene		
825427	100	1 / Pack
825428	200	1 / Pack
825429	315	1 / Pack
Aluminium		
825431	100	1 / Pack
825432	200	1 / Pack
825433	315	1 / Pack

FLOOR MARKING

Order Ref.	Diameter (mm)	Total Qty/Pack
Anti-skid Laminated Polyester		
825426	500	1 / Pack

MINI-PICTOGRAMS

Order Ref.	Diameter (mm)	Total Qty/Pack
Laminated Polyester		
825419	25	7 / Pack
Vinyl		
825417	15	54 / Pack



PICTOGRAMS ON ROLLS

Order Ref.	Diameter (mm)	Total Qty/Pack
Laminated Polyester		
825418	25	250 / Roll
825420	50	250 / Roll
825422	100	250 / Roll



PHOTOLUMINESCENT SIGNS

Order Ref.	Diameter (mm)	Class	Total Qty/Pack
Class B Photoluminescent Polyester			
836078	150	Class B	1 / Pack
Class C Photoluminescent Polyester			
836079	150	Class C	1 / Pack
Class B Photoluminescent Polypropylene			
836076	150	Class B	1 / Pack
Class C Photoluminescent Polypropylene			
836077	150	Class C	1 / Pack
Class C Photoluminescent Aluminium			
836075	150	Class C	1 / Pack

SIGNS WITH TEXT



Order Ref.	Width (mm)	Height (mm)	Layout	Legend	Total Qty/Pack
Polypropylene					
825489	150	50	Landscape	Do not use this lift for people	1 / Pack
825490	297	74	Landscape	Do not use this lift for people	1 / Pack
825492	450	150	Landscape	Do not use this lift for people	1 / Pack
825493	600	200	Landscape	Do not use this lift for people	1 / Pack
825486	148	210	Portrait	Do not use this lift for people	1 / Pack
825487	210	297	Portrait	Do not use this lift for people	1 / Pack
825491	297	105	Portrait	Do not use this lift for people	1 / Pack
825488	297	420	Portrait	Do not use this lift for people	1 / Pack
Aluminium					
825497	150	50	Landscape	Do not use this lift for people	1 / Pack
825499	450	150	Landscape	Do not use this lift for people	1 / Pack
825494	148	210	Portrait	Do not use this lift for people	1 / Pack
825495	210	297	Portrait	Do not use this lift for people	1 / Pack
825498	297	105	Portrait	Do not use this lift for people	1 / Pack
825496	297	420	Portrait	Do not use this lift for people	1 / Pack
Laminated Polyester					
825481	150	50	Landscape	Do not use this lift for people	1 / Pack
825482	297	74	Landscape	Do not use this lift for people	1 / Pack
825484	450	150	Landscape	Do not use this lift for people	1 / Pack
825485	600	200	Landscape	Do not use this lift for people	1 / Pack
825478	148	210	Portrait	Do not use this lift for people	1 / Pack
825479	210	297	Portrait	Do not use this lift for people	1 / Pack
825483	297	105	Portrait	Do not use this lift for people	1 / Pack
825480	297	420	Portrait	Do not use this lift for people	1 / Pack

i For all material properties and applications, see pages 4-5

BRADY Customise-it See page 196 to order your custom-made signs.

Complies with EN ISO 7010

P028 : Do NOT WEAR GLOVES

To protect the hands, gloves are sometimes compulsory. However, in other circumstances, these same gloves are prohibited.



SIGNS

Order Ref.	Diameter (mm)	Total Qty/Pack
Laminated Polyester		
825570	50	2 / Pack
825572	100	1 / Pack
825573	200	1 / Pack
825574	315	1 / Pack
Polypropylene		
825576	100	1 / Pack
825577	200	1 / Pack
825578	315	1 / Pack
Aluminium		
825580	100	1 / Pack
825581	200	1 / Pack
825582	315	1 / Pack

MINI-PICTOGRAMS

Order Ref.	Diameter (mm)	Total Qty/Pack
Laminated Polyester		
825568	25	7 / Pack
Vinyl		
825566	15	54 / Pack



PICTOGRAMS ON ROLLS

Order Ref.	Diameter (mm)	Total Qty/Pack
Laminated Polyester		
825567	25	250 / Roll
825569	50	250 / Roll
825571	100	250 / Roll

SIGNS WITH TEXT



Order Ref.	Width (mm)	Height (mm)	Layout	Legend	Total Qty/Pack
Polypropylene					
825638	150	50	Landscape	Do not wear gloves	1 / Pack
825639	297	74	Landscape	Do not wear gloves	1 / Pack
825641	450	150	Landscape	Do not wear gloves	1 / Pack
825642	600	200	Landscape	Do not wear gloves	1 / Pack
825635	148	210	Portrait	Do not wear gloves	1 / Pack
825636	210	297	Portrait	Do not wear gloves	1 / Pack
825640	297	105	Portrait	Do not wear gloves	1 / Pack
825637	297	420	Portrait	Do not wear gloves	1 / Pack
Aluminium					
825646	150	50	Landscape	Do not wear gloves	1 / Pack
825648	450	150	Landscape	Do not wear gloves	1 / Pack
825643	148	210	Portrait	Do not wear gloves	1 / Pack
825644	210	297	Portrait	Do not wear gloves	1 / Pack
825647	297	105	Portrait	Do not wear gloves	1 / Pack
825645	297	420	Portrait	Do not wear gloves	1 / Pack
Laminated Polyester					
825630	150	50	Landscape	Do not wear gloves	1 / Pack
825631	297	74	Landscape	Do not wear gloves	1 / Pack
825633	450	150	Landscape	Do not wear gloves	1 / Pack
825634	600	200	Landscape	Do not wear gloves	1 / Pack
825627	148	210	Portrait	Do not wear gloves	1 / Pack
825628	210	297	Portrait	Do not wear gloves	1 / Pack
825632	297	105	Portrait	Do not wear gloves	1 / Pack
825629	297	420	Portrait	Do not wear gloves	1 / Pack



PHOTOLUMINESCENT SIGNS

Order Ref.	Diameter (mm)	Class	Total Qty/Pack
Class B Photoluminescent Polyester			
836083	150	Class B	1 / Pack
Class C Photoluminescent Polyester			
836084	150	Class C	1 / Pack
Class B Photoluminescent Polypropylene			
836081	150	Class B	1 / Pack
Class C Photoluminescent Polypropylene			
836082	150	Class C	1 / Pack
Class C Photoluminescent Aluminium			
836080	150	Class C	1 / Pack

i For all material properties and applications, see pages 4-5

BRADY Customise-it See page 196 to order your custom-made signs.



P029 : No PHOTOGRAPHY

In order to protect work or secrets, or simply to avoid distractions, photography may be prohibited.



SIGNS

Order Ref.	Diameter (mm)	Total Qty/Pack
Laminated Polyester		
825719	50	2 / Pack
825721	100	1 / Pack
825722	200	1 / Pack
825723	315	1 / Pack
Polypropylene		
825725	100	1 / Pack
825726	200	1 / Pack
825727	315	1 / Pack
Aluminium		
825729	100	1 / Pack
825730	200	1 / Pack
825731	315	1 / Pack

FLOOR MARKING

Order Ref.	Diameter (mm)	Total Qty/Pack
Anti-skid Laminated Polyester		
825724	500	1 / Pack

MINI-PICTOGRAMS

Order Ref.	Diameter (mm)	Total Qty/Pack
Laminated Polyester		
825717	25	7 / Pack
Vinyl		
825715	15	54 / Pack

SIGNS WITH TEXT



Order Ref.	Width (mm)	Height (mm)	Layout	Legend	Total Qty/Pack
Polypropylene					
825787	150	50	Landscape	No photography	1 / Pack
825788	297	74	Landscape	No photography	1 / Pack
825790	450	150	Landscape	No photography	1 / Pack
825791	600	200	Landscape	No photography	1 / Pack
825784	148	210	Portrait	No photography	1 / Pack
825785	210	297	Portrait	No photography	1 / Pack
825789	297	105	Portrait	No photography	1 / Pack
825786	297	420	Portrait	No photography	1 / Pack
Aluminium					
825795	150	50	Landscape	No photography	1 / Pack
825797	450	150	Landscape	No photography	1 / Pack
825792	148	210	Portrait	No photography	1 / Pack
825793	210	297	Portrait	No photography	1 / Pack
825796	297	105	Portrait	No photography	1 / Pack
825794	297	420	Portrait	No photography	1 / Pack
Laminated Polyester					
825779	150	50	Landscape	No photography	1 / Pack
825780	297	74	Landscape	No photography	1 / Pack
825782	450	150	Landscape	No photography	1 / Pack
825783	600	200	Landscape	No photography	1 / Pack
825776	148	210	Portrait	No photography	1 / Pack
825777	210	297	Portrait	No photography	1 / Pack
825781	297	105	Portrait	No photography	1 / Pack
825778	297	420	Portrait	No photography	1 / Pack



PICTOGRAMS ON ROLLS

Order Ref.	Diameter (mm)	Total Qty/Pack
Laminated Polyester		
825716	25	250 / Roll
825718	50	250 / Roll
825720	100	250 / Roll



PHOTOLUMINESCENT SIGNS

Order Ref.	Diameter (mm)	Class	Total Qty/Pack
Class B Photoluminescent Polyester			
836088	150	Class B	1 / Pack
Class C Photoluminescent Polyester			
836089	150	Class C	1 / Pack
Class B Photoluminescent Polypropylene			
836086	150	Class B	1 / Pack
Class C Photoluminescent Polypropylene			
836087	150	Class C	1 / Pack
Class C Photoluminescent Aluminium			
836085	150	Class C	1 / Pack

i For all material properties and applications, see pages 4-5

BRADY Customise-it See page 196 to order your custom-made signs.

Complies with EN ISO 7010

P030 : Do NOT TIE KNOTS IN ROPE

A knot in a rope could damage an installation or cause an incident. It is therefore sometimes preferable to provide a reminder of this.



SIGNS

Order Ref.	Diameter (mm)	Total Qty/Pack
Laminated Polyester		
825868	50	2 / Pack
825870	100	1 / Pack
825871	200	1 / Pack
825872	315	1 / Pack
Polypropylene		
825874	100	1 / Pack
825875	200	1 / Pack
825876	315	1 / Pack
Aluminium		
825878	100	1 / Pack
825879	200	1 / Pack
825880	315	1 / Pack

MINI-PICTOGRAMS

Order Ref.	Diameter (mm)	Total Qty/Pack
Laminated Polyester		
825866	25	7 / Pack
Vinyl		
825864	15	54 / Pack



PICTOGRAMS ON ROLLS

Order Ref.	Diameter (mm)	Total Qty/Pack
Laminated Polyester		
825865	25	250 / Roll
825867	50	250 / Roll
825869	100	250 / Roll



PHOTOLUMINESCENT SIGNS

Order Ref.	Diameter (mm)	Class	Total Qty/Pack
Class B Photoluminescent Polyester			
836093	150	Class B	1 / Pack
Class C Photoluminescent Polyester			
836094	150	Class C	1 / Pack
Class B Photoluminescent Polypropylene			
836091	150	Class B	1 / Pack
Class C Photoluminescent Polypropylene			
836092	150	Class C	1 / Pack
Class C Photoluminescent Aluminium			
836090	150	Class C	1 / Pack

SIGNS WITH TEXT



Order Ref.	Width (mm)	Height (mm)	Layout	Legend	Total Qty/Pack
Polypropylene					
825936	150	50	Landscape	Do not tie knots in rope	1 / Pack
825937	297	74	Landscape	Do not tie knots in rope	1 / Pack
825939	450	150	Landscape	Do not tie knots in rope	1 / Pack
825940	600	200	Landscape	Do not tie knots in rope	1 / Pack
825933	148	210	Portrait	Do not tie knots in rope	1 / Pack
825934	210	297	Portrait	Do not tie knots in rope	1 / Pack
825938	297	105	Portrait	Do not tie knots in rope	1 / Pack
825935	297	420	Portrait	Do not tie knots in rope	1 / Pack
Aluminium					
825944	150	50	Landscape	Do not tie knots in rope	1 / Pack
825946	450	150	Landscape	Do not tie knots in rope	1 / Pack
825941	148	210	Portrait	Do not tie knots in rope	1 / Pack
825942	210	297	Portrait	Do not tie knots in rope	1 / Pack
825945	297	105	Portrait	Do not tie knots in rope	1 / Pack
825943	297	420	Portrait	Do not tie knots in rope	1 / Pack
Laminated Polyester					
825928	150	50	Landscape	Do not tie knots in rope	1 / Pack
825929	297	74	Landscape	Do not tie knots in rope	1 / Pack
825931	450	150	Landscape	Do not tie knots in rope	1 / Pack
825932	600	200	Landscape	Do not tie knots in rope	1 / Pack
825925	148	210	Portrait	Do not tie knots in rope	1 / Pack
825926	210	297	Portrait	Do not tie knots in rope	1 / Pack
825930	297	105	Portrait	Do not tie knots in rope	1 / Pack
825927	297	420	Portrait	Do not tie knots in rope	1 / Pack

i For all material properties and applications, see pages 4-5

BRADY Customise-it See page 196 to order your custom-made signs.



P031 : Do NOT ALTER THE STATE OF THE SWITCH

Altering the state of a switch always has consequences. However, in certain circumstances, it is essential to give a reminder that this position must not be changed.



SIGNS

Order Ref.	Diameter (mm)	Total Qty/Pack
Laminated Polyester		
826017	50	2 / Pack
826019	100	1 / Pack
826020	200	1 / Pack
826021	315	1 / Pack
Polypropylene		
826023	100	1 / Pack
826024	200	1 / Pack
826025	315	1 / Pack
Aluminium		
826027	100	1 / Pack
826028	200	1 / Pack
826029	315	1 / Pack

MINI-PICTOGRAMS

Order Ref.	Diameter (mm)	Total Qty/Pack
Laminated Polyester		
826015	25	7 / Pack
Vinyl		
826013	15	54 / Pack



PICTOGRAMS ON ROLLS

Order Ref.	Diameter (mm)	Total Qty/Pack
Laminated Polyester		
826014	25	250 / Roll
826016	50	250 / Roll
826018	100	250 / Roll



PHOTOLUMINESCENT SIGNS

Order Ref.	Diameter (mm)	Class	Total Qty/Pack
Class B Photoluminescent Polyester			
836098	150	Class B	1 / Pack
Class C Photoluminescent Polyester			
836099	150	Class C	1 / Pack
Class B Photoluminescent Polypropylene			
836096	150	Class B	1 / Pack
Class C Photoluminescent Polypropylene			
836097	150	Class C	1 / Pack
Class C Photoluminescent Aluminium			
836095	150	Class C	1 / Pack

SIGNS WITH TEXT



Order Ref.	Width (mm)	Height (mm)	Layout	Legend	Total Qty/Pack
Polypropylene					
826085	150	50	Landscape	Do not alter the switch	1 / Pack
826086	297	74	Landscape	Do not alter the switch	1 / Pack
826088	450	150	Landscape	Do not alter the switch	1 / Pack
826089	600	200	Landscape	Do not alter the switch	1 / Pack
826082	148	210	Portrait	Do not alter the switch	1 / Pack
826083	210	297	Portrait	Do not alter the switch	1 / Pack
826087	297	105	Portrait	Do not alter the switch	1 / Pack
826084	297	420	Portrait	Do not alter the switch	1 / Pack
Aluminium					
826093	150	50	Landscape	Do not alter the switch	1 / Pack
826095	450	150	Landscape	Do not alter the switch	1 / Pack
826090	148	210	Portrait	Do not alter the switch	1 / Pack
826091	210	297	Portrait	Do not alter the switch	1 / Pack
826094	297	105	Portrait	Do not alter the switch	1 / Pack
826092	297	420	Portrait	Do not alter the switch	1 / Pack
Laminated Polyester					
826077	150	50	Landscape	Do not alter the switch	1 / Pack
826078	297	74	Landscape	Do not alter the switch	1 / Pack
826080	450	150	Landscape	Do not alter the switch	1 / Pack
826081	600	200	Landscape	Do not alter the switch	1 / Pack
826074	148	210	Portrait	Do not alter the switch	1 / Pack
826075	210	297	Portrait	Do not alter the switch	1 / Pack
826079	297	105	Portrait	Do not alter the switch	1 / Pack
826076	297	420	Portrait	Do not alter the switch	1 / Pack

i For all material properties and applications, see pages 4-5

BRADY Customise-it See page 196 to order your custom-made signs.

Complies with EN ISO 7010

P032 : Do NOT USE FOR FACE GRINDING

Flat surfaces can be ground using the different faces of the grinder. However, some tools cannot be used for flat grinding, this must therefore be pointed out.



SIGNS

Order Ref.	Diameter (mm)	Total Qty/Pack
Laminated Polyester		
826166	50	2 / Pack
826168	100	1 / Pack
826169	200	1 / Pack
826170	315	1 / Pack
Polypropylene		
826172	100	1 / Pack
826173	200	1 / Pack
826174	315	1 / Pack
Aluminium		
826176	100	1 / Pack
826177	200	1 / Pack
826178	315	1 / Pack



PICTOGRAMS ON ROLLS

Order Ref.	Diameter (mm)	Total Qty/Pack
Laminated Polyester		
826163	25	250 / Roll
826165	50	250 / Roll
826167	100	250 / Roll

SIGNS WITH TEXT



Order Ref.	Width (mm)	Height (mm)	Layout	Legend	Total Qty/Pack
Polypropylene					
826234	150	50	Landscape	Do not use for face grinding	1 / Pack
826235	297	74	Landscape	Do not use for face grinding	1 / Pack
826237	450	150	Landscape	Do not use for face grinding	1 / Pack
826238	600	200	Landscape	Do not use for face grinding	1 / Pack
826231	148	210	Portrait	Do not use for face grinding	1 / Pack
826232	210	297	Portrait	Do not use for face grinding	1 / Pack
826236	297	105	Portrait	Do not use for face grinding	1 / Pack
826233	297	420	Portrait	Do not use for face grinding	1 / Pack
Aluminium					
826242	150	50	Landscape	Do not use for face grinding	1 / Pack
826244	450	150	Landscape	Do not use for face grinding	1 / Pack
826239	148	210	Portrait	Do not use for face grinding	1 / Pack
826240	210	297	Portrait	Do not use for face grinding	1 / Pack
826243	297	105	Portrait	Do not use for face grinding	1 / Pack
826241	297	420	Portrait	Do not use for face grinding	1 / Pack
Laminated Polyester					
826226	150	50	Landscape	Do not use for face grinding	1 / Pack
826227	297	74	Landscape	Do not use for face grinding	1 / Pack
826229	450	150	Landscape	Do not use for face grinding	1 / Pack
826230	600	200	Landscape	Do not use for face grinding	1 / Pack
826223	148	210	Portrait	Do not use for face grinding	1 / Pack
826224	210	297	Portrait	Do not use for face grinding	1 / Pack
826228	297	105	Portrait	Do not use for face grinding	1 / Pack
826225	297	420	Portrait	Do not use for face grinding	1 / Pack

Complies with EN ISO 7010

P033 : Do NOT USE FOR WET GRINDING

The surfaces can be ground using the different faces of the grinder. However, some tools cannot be used for wet grinding, this must therefore be pointed out.



SIGNS

Order Ref.	Diameter (mm)	Total Qty/Pack
Laminated Polyester		
826315	50	2 / Pack
826317	100	1 / Pack
826318	200	1 / Pack
826319	315	1 / Pack
Polypropylene		
826321	100	1 / Pack
826322	200	1 / Pack
826323	315	1 / Pack
Aluminium		
826325	100	1 / Pack
826326	200	1 / Pack
826327	315	1 / Pack



PICTOGRAMS ON ROLLS

Order Ref.	Diameter (mm)	Total Qty/Pack
Laminated Polyester		
826312	25	250 / Roll
826314	50	250 / Roll
826316	100	250 / Roll

SIGNS WITH TEXT



Order Ref.	Width (mm)	Height (mm)	Layout	Legend	Total Qty/Pack
Polypropylene					
826383	150	50	Landscape	Do not use for wet grinding	1 / Pack
826384	297	74	Landscape	Do not use for wet grinding	1 / Pack
826386	450	150	Landscape	Do not use for wet grinding	1 / Pack
826387	600	200	Landscape	Do not use for wet grinding	1 / Pack
826380	148	210	Portrait	Do not use for wet grinding	1 / Pack
826381	210	297	Portrait	Do not use for wet grinding	1 / Pack
826385	297	105	Portrait	Do not use for wet grinding	1 / Pack
826382	297	420	Portrait	Do not use for wet grinding	1 / Pack
Aluminium					
826391	150	50	Landscape	Do not use for wet grinding	1 / Pack
826393	450	150	Landscape	Do not use for wet grinding	1 / Pack
826388	148	210	Portrait	Do not use for wet grinding	1 / Pack
826389	210	297	Portrait	Do not use for wet grinding	1 / Pack
826392	297	105	Portrait	Do not use for wet grinding	1 / Pack
826390	297	420	Portrait	Do not use for wet grinding	1 / Pack
Laminated Polyester					
826375	150	50	Landscape	Do not use for wet grinding	1 / Pack
826376	297	74	Landscape	Do not use for wet grinding	1 / Pack
826378	450	150	Landscape	Do not use for wet grinding	1 / Pack
826379	600	200	Landscape	Do not use for wet grinding	1 / Pack
826372	148	210	Portrait	Do not use for wet grinding	1 / Pack
826373	210	297	Portrait	Do not use for wet grinding	1 / Pack
826377	297	105	Portrait	Do not use for wet grinding	1 / Pack
826374	297	420	Portrait	Do not use for wet grinding	1 / Pack



P034 : Do NOT USE WITH HAND-HELD GRINDING MACHINE

Certain products cannot be ground with a hand-held grinding machine.



SIGNS

Order Ref.	Diameter (mm)	Total Qty/Pack
Laminated Polyester		
826464	50	2 / Pack
826466	100	1 / Pack
826467	200	1 / Pack
826468	315	1 / Pack
Polypropylene		
826470	100	1 / Pack
826471	200	1 / Pack
826472	315	1 / Pack
Aluminium		
826474	100	1 / Pack
826475	200	1 / Pack
826476	315	1 / Pack

MINI-PICTOGRAMS

Order Ref.	Diameter (mm)	Total Qty/Pack
Laminated Polyester		
826462	25	7 / Pack
Vinyl		
826460	15	54 / Pack

SIGNS WITH TEXT



Order Ref.	Width (mm)	Height (mm)	Layout	Legend	Total Qty/Pack
Polypropylene					
826532	150	50	Landscape	Do not use with hand-held grinding machine	1 / Pack
826533	297	74	Landscape	Do not use with hand-held grinding machine	1 / Pack
826535	450	150	Landscape	Do not use with hand-held grinding machine	1 / Pack
826536	600	200	Landscape	Do not use with hand-held grinding machine	1 / Pack
826529	148	210	Portrait	Do not use with hand-held grinding machine	1 / Pack
826530	210	297	Portrait	Do not use with hand-held grinding machine	1 / Pack
826534	297	105	Portrait	Do not use with hand-held grinding machine	1 / Pack
826531	297	420	Portrait	Do not use with hand-held grinding machine	1 / Pack
Aluminium					
826540	150	50	Landscape	Do not use with hand-held grinding machine	1 / Pack
826542	450	150	Landscape	Do not use with hand-held grinding machine	1 / Pack
826537	148	210	Portrait	Do not use with hand-held grinding machine	1 / Pack
826538	210	297	Portrait	Do not use with hand-held grinding machine	1 / Pack
826541	297	105	Portrait	Do not use with hand-held grinding machine	1 / Pack
826539	297	420	Portrait	Do not use with hand-held grinding machine	1 / Pack
Laminated Polyester					
826524	150	50	Landscape	Do not use with hand-held grinding machine	1 / Pack
826525	297	74	Landscape	Do not use with hand-held grinding machine	1 / Pack
826527	450	150	Landscape	Do not use with hand-held grinding machine	1 / Pack
826528	600	200	Landscape	Do not use with hand-held grinding machine	1 / Pack
826521	148	210	Portrait	Do not use with hand-held grinding machine	1 / Pack
826522	210	297	Portrait	Do not use with hand-held grinding machine	1 / Pack
826526	297	105	Portrait	Do not use with hand-held grinding machine	1 / Pack
826523	297	420	Portrait	Do not use with hand-held grinding machine	1 / Pack



PICTOGRAMS ON ROLLS

Order Ref.	Diameter (mm)	Total Qty/Pack
Laminated Polyester		
826461	25	250 / Roll
826463	50	250 / Roll
826465	100	250 / Roll

i LOCKOUT/TAGOUT SYSTEMS

Lockout/Tagout is a procedure created to protect workers involved in the maintenance and servicing of tools against the accidental starting of the various energy sources. This is obtained by mechanically isolating, identifying and locking these energy sources. Contact your Brady distributor to find out more about our full range of lockout/tagout systems.

Lockout / Tagout

Solutions for Hazardous Energy Control
Create, visualise and manage your Isolation Programme

Complies with EN ISO 7010

P035 : Do NOT WEAR METAL-STUDED FOOTWEAR

Metal-studded footwear can represent a risk if it is worn in an unsuitable environment. It is therefore vital to point out that it is prohibited.



SIGNS

Order Ref.	Diameter (mm)	Total Qty/Pack
Laminated Polyester		
831336	50	2 / Pack
831338	100	1 / Pack
831339	200	1 / Pack
831340	315	1 / Pack
Polypropylene		
831342	100	1 / Pack
831343	200	1 / Pack
831344	315	1 / Pack
Aluminium		
831346	100	1 / Pack
831347	200	1 / Pack
831348	315	1 / Pack

FLOOR MARKING

Order Ref.	Diameter (mm)	Total Qty/Pack
Anti-skid Laminated Polyester		
831341	500	1 / Pack

MINI-PICTOGRAMS

Order Ref.	Diameter (mm)	Total Qty/Pack
Laminated Polyester		
831334	25	7 / Pack
831335	50	250 / Roll



PICTOGRAMS ON ROLLS

Order Ref.	Diameter (mm)	Total Qty/Pack
Laminated Polyester		
831333	25	250 / Roll
831335	50	250 / Roll
831337	100	250 / Roll



PHOTOLUMINESCENT SIGNS

Order Ref.	Diameter (mm)	Class	Total Qty/Pack
Class B Photoluminescent Polyester			
836118	150	Class B	1 / Pack
Class C Photoluminescent Polyester			
836119	150	Class C	1 / Pack
Class B Photoluminescent Polypropylene			
836116	150	Class B	1 / Pack
Class C Photoluminescent Polypropylene			
836117	150	Class C	1 / Pack
Class C Photoluminescent Aluminium			
836115	150	Class C	1 / Pack

Complies with EN ISO 7010

P036 : No CHILDREN ALLOWED

For their safety, children are not allowed in certain places.



SIGNS

Order Ref.	Diameter (mm)	Total Qty/Pack
Laminated Polyester		
831353	50	2 / Pack
831355	100	1 / Pack
831356	200	1 / Pack
831357	315	1 / Pack
Polypropylene		
831359	100	1 / Pack
831360	200	1 / Pack
831361	315	1 / Pack
Aluminium		
831363	100	1 / Pack
831364	200	1 / Pack
831365	315	1 / Pack

FLOOR MARKING

Order Ref.	Diameter (mm)	Total Qty/Pack
Anti-skid Laminated Polyester		
831358	500	1 / Pack

MINI-PICTOGRAMS

Order Ref.	Diameter (mm)	Total Qty/Pack
Laminated Polyester		
831351	25	7 / Pack
Vinyl		
831349	15	54 / Pack



PICTOGRAMS ON ROLLS

Order Ref.	Diameter (mm)	Total Qty/Pack
Laminated Polyester		
831350	25	250 / Roll
831352	50	250 / Roll
831354	100	250 / Roll



PHOTOLUMINESCENT SIGNS

Order Ref.	Diameter (mm)	Class	Total Qty/Pack
Class B Photoluminescent Polyester			
836123	150	Class B	1 / Pack
Class C Photoluminescent Polyester			
836124	150	Class C	1 / Pack
Class B Photoluminescent Polypropylene			
836121	150	Class B	1 / Pack
Class C Photoluminescent Polypropylene			
836122	150	Class C	1 / Pack
Class C Photoluminescent Aluminium			
836120	150	Class C	1 / Pack

i For all material properties and applications, see pages 4-5

BRADY Customise-it See page 196 to order your custom-made signs.



P037 : Do NOT LEAVE THE TOW-TRACK

In mountain resorts, some rules must be respected for the safety of everyone. One of them bans getting off the ski lift.



SIGNS

Order Ref.	Diameter (mm)	Total Qty/Pack
Laminated Polyester		
135774	100	1 / Pack
135775	150	1 / Pack
135776	200	1 / Pack
Polypropylene		
135768	100	1 / Pack
135769	150	1 / Pack
135770	200	1 / Pack
Aluminium		
135771	100	1 / Pack
135772	150	1 / Pack
135773	200	1 / Pack



PHOTOLUMINESCENT SIGNS

Order Ref.	Diameter (mm)	Class	Total Qty/Pack
Class B Photoluminescent Polyester			
135783	100	Class B	1 / Pack
135784	150	Class B	1 / Pack
135785	200	Class B	1 / Pack
Class C Photoluminescent Polyester			
135792	100	Class C	1 / Pack
135793	150	Class C	1 / Pack
135794	200	Class C	1 / Pack
Class B Photoluminescent Polypropylene			
135777	100	Class B	1 / Pack
135778	150	Class B	1 / Pack
135779	200	Class B	1 / Pack
Class C Photoluminescent Polypropylene			
135786	100	Class C	1 / Pack
135787	150	Class C	1 / Pack
135788	200	Class C	1 / Pack
Class C Photoluminescent Aluminium			
135789	100	Class C	1 / Pack
135790	150	Class C	1 / Pack
135791	200	Class C	1 / Pack



P038 : Do NOT SWING THE CHAIR

In mountain resorts, some rules must be respected for the safety of everyone. One of them prohibits swinging the chairs.



SIGNS

Order Ref.	Diameter (mm)	Total Qty/Pack
Laminated Polyester		
135802	100	1 / Pack
135803	150	1 / Pack
135804	200	1 / Pack
Polypropylene		
135795	100	1 / Pack
135796	150	1 / Pack
135797	200	1 / Pack
Aluminium		
135799	100	1 / Pack
135800	150	1 / Pack
135801	200	1 / Pack



PHOTOLUMINESCENT SIGNS

Order Ref.	Diameter (mm)	Class	Total Qty/Pack
Class B Photoluminescent Polyester			
135811	100	Class B	1 / Pack
135812	150	Class B	1 / Pack
135813	200	Class B	1 / Pack
Class C Photoluminescent Polyester			
135820	100	Class C	1 / Pack
135821	150	Class C	1 / Pack
135822	200	Class C	1 / Pack
Class B Photoluminescent Polypropylene			
135805	100	Class B	1 / Pack
135806	150	Class B	1 / Pack
135807	200	Class B	1 / Pack
Class C Photoluminescent Polypropylene			
135814	100	Class C	1 / Pack
135815	150	Class C	1 / Pack
135816	200	Class C	1 / Pack
Class C Photoluminescent Aluminium			
135817	100	Class C	1 / Pack
135818	150	Class C	1 / Pack
135819	200	Class C	1 / Pack

i For all material properties and applications, see pages 4-5

BRADY Customise-it See page 196 to order your custom-made signs.

Complies with EN ISO 7010

P040 : Do NOT SET OFF FIREWORKS

Prohibits people from setting of fireworks in areas where this would be dangerous or otherwise highly unwanted.



SIGNS

Order Ref.	Diameter (mm)	Total Qty/Pack
Laminated Polyester		
196777	50	2 / Pack
196778	100	1 / Pack
196779	200	1 / Pack
196780	315	1 / Pack
Polypropylene		
196781	100	1 / Pack
196782	200	1 / Pack
196783	315	1 / Pack
Aluminium		
196784	100	1 / Pack
196785	200	1 / Pack
196786	315	1 / Pack

FLOOR MARKING

Order Ref.	Diameter (mm)	Total Qty/Pack
Anti-skid Laminated Polyester		
196820	500	1 / Pack

MINI-PICTOGRAMS

Order Ref.	Diameter (mm)	Total Qty/Pack
Laminated Polyester		
196814	20	18 / Pack
196815	25	7 / Pack
196816	30	15 / Pack
Vinyl		
196813	15	54 / Pack



PICTOGRAMS ON ROLLS

Order Ref.	Diameter (mm)	Total Qty/Pack
Laminated Polyester		
196817	25	250 / Pack
196818	50	250 / Pack
196819	100	250 / Pack

SIGNS WITH TEXT



Order Ref.	Width (mm)	Height (mm)	Layout	Legend	Total Qty/Pack
Polypropylene					
196794	150	50	Landscape	Do not set off fireworks	1 / Pack
196795	297	105	Landscape	Do not set off fireworks	1 / Pack
196796	450	150	Landscape	Do not set off fireworks	1 / Pack
196797	600	200	Landscape	Do not set off fireworks	1 / Pack
196798	148	210	Portrait	Do not set off fireworks	1 / Pack
196799	210	297	Portrait	Do not set off fireworks	1 / Pack
196800	297	420	Portrait	Do not set off fireworks	1 / Pack
Aluminium					
196803	150	50	Landscape	Do not set off fireworks	1 / Pack
196804	297	105	Landscape	Do not set off fireworks	1 / Pack
196805	450	150	Landscape	Do not set off fireworks	1 / Pack
196806	148	210	Portrait	Do not set off fireworks	1 / Pack
196807	210	297	Portrait	Do not set off fireworks	1 / Pack
196808	297	420	Portrait	Do not set off fireworks	1 / Pack
Laminated Polyester					
196787	150	50	Landscape	Do not set off fireworks	1 / Pack
196788	297	105	Landscape	Do not set off fireworks	1 / Pack
196789	450	150	Landscape	Do not set off fireworks	1 / Pack
196790	600	200	Landscape	Do not set off fireworks	1 / Pack
196791	148	210	Portrait	Do not set off fireworks	1 / Pack
196792	210	297	Portrait	Do not set off fireworks	1 / Pack
196793	297	420	Portrait	Do not set off fireworks	1 / Pack

PHOTOLUMINESCENT SIGNS



Order Ref.	Diameter (mm)	Total Qty/Pack
Class B Photoluminescent Polyester		
196809	150	1 / Pack
Class C Photoluminescent Polyester		
196810	150	1 / Pack
Class B Photoluminescent Polypropylene		
196811	150	1 / Pack
Class C Photoluminescent Polypropylene		
196812	150	1 / Pack
Class C Photoluminescent Aluminium		
197585	150	1 / Pack

i For all material properties and applications, see pages 4-5

BRADY Customise-it See page 196 to order your custom-made signs.



P041 : No LEANING AGAINST

Prohibits people from leaning against large or stacked objects that could easily fall over.



SIGNS

Order Ref.	Diameter (mm)	Total Qty/ Pack
Laminated Polyester		
196881	50	2 / Pack
196882	100	1 / Pack
196883	200	1 / Pack
196884	315	1 / Pack
Polypropylene		
196885	100	1 / Pack
196886	200	1 / Pack
196887	315	1 / Pack
Aluminium		
196888	100	1 / Pack
196889	200	1 / Pack
196890	315	1 / Pack

FLOOR MARKING

Order Ref.	Diameter (mm)	Total Qty/ Pack
Anti-skid Laminated Polyester		
196922	500	1 / Pack

MINI-PICTOGRAMS

Order Ref.	Diameter (mm)	Total Qty/ Pack
Laminated Polyester		
196916	20	18 / Pack
196917	25	7 / Pack
196918	30	15 / Pack
Vinyl		
196915	15	54 / Pack



PICTOGRAMS ON ROLLS

Order Ref.	Diameter (mm)	Total Qty/ Pack
Laminated Polyester		
196919	25	250 / Pack
196920	50	250 / Pack
196921	100	250 / Pack

SIGNS WITH TEXT



Order Ref.	Width (mm)	Height (mm)	Layout	Legend	Total Qty/ Pack
Polypropylene					
196898	150	50	Landscape	Do not lean against	1 / Pack
196899	297	105	Landscape	Do not lean against	1 / Pack
196900	450	150	Landscape	Do not lean against	1 / Pack
196901	600	200	Landscape	Do not lean against	1 / Pack
196902	148	210	Portrait	Do not lean against	1 / Pack
196903	210	297	Portrait	Do not lean against	1 / Pack
196904	297	420	Portrait	Do not lean against	1 / Pack
Aluminium					
196905	150	50	Landscape	Do not lean against	1 / Pack
196906	297	105	Landscape	Do not lean against	1 / Pack
196907	450	150	Landscape	Do not lean against	1 / Pack
196908	148	210	Portrait	Do not lean against	1 / Pack
196909	210	297	Portrait	Do not lean against	1 / Pack
196910	297	420	Portrait	Do not lean against	1 / Pack
Laminated Polyester					
196891	150	50	Landscape	Do not lean against	1 / Pack
196892	297	105	Landscape	Do not lean against	1 / Pack
196893	450	150	Landscape	Do not lean against	1 / Pack
196894	600	200	Landscape	Do not lean against	1 / Pack
196895	148	210	Portrait	Do not lean against	1 / Pack
196896	210	297	Portrait	Do not lean against	1 / Pack
196897	297	420	Portrait	Do not lean against	1 / Pack

PHOTOLUMINESCENT SIGNS



Order Ref.	Diameter (mm)	Class	Total Qty/ Pack
Class B Photoluminescent Polyester			
196911	150	Class B	1 / Pack
Class C Photoluminescent Polyester			
196912	150	Class C	1 / Pack
Class B Photoluminescent Polypropylene			
196913	150	Class B	1 / Pack
Class C Photoluminescent Polypropylene			
196914	150	Class C	1 / Pack
Class C Photoluminescent Aluminium			
197586	150	Class C	1 / Pack

i For all material properties and applications, see pages 4-5

BRADY Customise-it See page 196 to order your custom-made signs.

Complies with EN ISO 7010

P042 : NOT FOR PREGNANT WOMEN

To prohibit pregnant women undertaking hazardous actions or activities



SIGNS

Order Ref.	Diameter (mm)	Total Qty/ Pack
Laminated Polyester		
196983	50	2 / Pack
196984	100	1 / Pack
196985	200	1 / Pack
196986	315	1 / Pack
Polypropylene		
196987	100	1 / Pack
196988	200	1 / Pack
196989	315	1 / Pack
Aluminium		
196990	100	1 / Pack
196991	200	1 / Pack
196992	315	1 / Pack

FLOOR MARKING

Order Ref.	Diameter (mm)	Total Qty/ Pack
Anti-skid Laminated Polyester		
197028	500	1 / Pack

MINI-PICTOGRAMS

Order Ref.	Diameter (mm)	Total Qty/ Pack
Laminated Polyester		
197021	20	18 / Pack
197022	25	7 / Pack
197023	30	15 / Pack
Vinyl		
197019	15	54 / Pack



PICTOGRAMS ON ROLLS

Order Ref.	Diameter (mm)	Total Qty/ Pack
Laminated Polyester		
197025	25	250 / Pack
197026	50	250 / Pack
197027	100	250 / Pack

SIGNS WITH TEXT



Order Ref.	Width (mm)	Height (mm)	Layout	Legend	Total Qty/ Pack
Polypropylene					
197000	150	50	Landscape	No pregnant women allowed	1 / Pack
197001	297	105	Landscape	No pregnant women allowed	1 / Pack
197002	450	150	Landscape	No pregnant women allowed	1 / Pack
197003	600	200	Landscape	No pregnant women allowed	1 / Pack
197004	148	210	Portrait	No pregnant women allowed	1 / Pack
197005	210	297	Portrait	No pregnant women allowed	1 / Pack
197006	297	420	Portrait	No pregnant women allowed	1 / Pack
Aluminium					
197007	150	50	Landscape	No pregnant women allowed	1 / Pack
197008	297	105	Landscape	No pregnant women allowed	1 / Pack
197009	450	150	Landscape	No pregnant women allowed	1 / Pack
197010	148	210	Portrait	No pregnant women allowed	1 / Pack
197011	210	297	Portrait	No pregnant women allowed	1 / Pack
197013	297	420	Portrait	No pregnant women allowed	1 / Pack
Laminated Polyester					
196993	150	50	Landscape	No pregnant women allowed	1 / Pack
196994	297	105	Landscape	No pregnant women allowed	1 / Pack
196995	450	150	Landscape	No pregnant women allowed	1 / Pack
196996	600	200	Landscape	No pregnant women allowed	1 / Pack
196997	148	210	Portrait	No pregnant women allowed	1 / Pack
196998	210	297	Portrait	No pregnant women allowed	1 / Pack
196999	297	420	Portrait	No pregnant women allowed	1 / Pack

PHOTOLUMINESCENT SIGNS



Order Ref.	Diameter (mm)	Class	Total Qty/ Pack
Class B Photoluminescent Polyester			
197014	150	Class B	1 / Pack
Class C Photoluminescent Polyester			
197015	150	Class C	1 / Pack
Class B Photoluminescent Polypropylene			
197017	150	Class B	1 / Pack
Class C Photoluminescent Polypropylene			
197018	150	Class C	1 / Pack
Class C Photoluminescent Aluminium			
197587	150	Class C	1 / Pack

i For all material properties and applications, see pages 4-5

BRADY Customise-it See page 196 to order your custom-made signs.



P043 : NOT FOR PEOPLE IN THE STATE OF INTOXICATION

Clearly indicates that a facility or area is out of bounds for anyone in the state of intoxication.



SIGNS

Order Ref.	Diameter (mm)	Total Qty/ Pack
Laminated Polyester		
198157	50	2 / Pack
198158	100	1 / Pack
198159	200	1 / Pack
198160	315	1 / Pack
Polypropylene		
198161	100	1 / Pack
198162	200	1 / Pack
198163	315	1 / Pack
Aluminium		
198164	100	1 / Pack
198165	200	1 / Pack
198166	315	1 / Pack

FLOOR MARKING

Order Ref.	Diameter (mm)	Total Qty/ Pack
Anti-skid Laminated Polyester		
198199	500	1 / Pack

MINI-PICTOGRAMS

Order Ref.	Diameter (mm)	Total Qty/ Pack
Laminated Polyester		
198193	20	18 / Pack
198194	25	7 / Pack
198195	30	15 / Pack
Vinyl		
198192	15	54 / Pack



PICTOGRAMS ON ROLLS

Order Ref.	Diameter (mm)	Total Qty/ Pack
Laminated Polyester		
198196	25	250 / Pack
198197	50	250 / Pack
198198	100	250 / Pack

SIGNS WITH TEXT



Order Ref.	Width (mm)	Height (mm)	Layout	Legend	Total Qty/ Pack
Laminated Polyester					
198167	150	50	Landscape	Do not use while intoxicated	1 / Pack
198168	297	105	Landscape	Do not use while intoxicated	1 / Pack
198169	450	150	Landscape	Do not use while intoxicated	1 / Pack
198170	600	200	Landscape	Do not use while intoxicated	1 / Pack
198171	148	210	Portrait	Do not use while intoxicated	1 / Pack
198172	210	297	Portrait	Do not use while intoxicated	1 / Pack
198173	297	420	Portrait	Do not use while intoxicated	1 / Pack
Polypropylene					
198174	150	50	Landscape	Do not use while intoxicated	1 / Pack
198175	297	105	Landscape	Do not use while intoxicated	1 / Pack
198176	450	150	Landscape	Do not use while intoxicated	1 / Pack
198177	600	200	Landscape	Do not use while intoxicated	1 / Pack
198178	148	210	Portrait	Do not use while intoxicated	1 / Pack
198179	210	297	Portrait	Do not use while intoxicated	1 / Pack
198180	297	420	Portrait	Do not use while intoxicated	1 / Pack
Aluminium					
198181	150	50	Landscape	Do not use while intoxicated	1 / Pack
198182	297	105	Landscape	Do not use while intoxicated	1 / Pack
198183	450	150	Landscape	Do not use while intoxicated	1 / Pack
198184	148	210	Portrait	Do not use while intoxicated	1 / Pack
198185	210	297	Portrait	Do not use while intoxicated	1 / Pack
198186	297	420	Portrait	Do not use while intoxicated	1 / Pack

PHOTOLUMINESCENT SIGNS



Order Ref.	Diameter (mm)	Total Qty/ Pack
Class B Photoluminescent Polyester		
198187	150	1 / Pack
Class C Photoluminescent Polyester		
198188	150	1 / Pack
Class B Photoluminescent Polypropylene		
198189	150	1 / Pack
Class C Photoluminescent Polypropylene		
198190	150	1 / Pack
Class C Photoluminescent Aluminium		
198191	150	1 / Pack

i For all material properties and applications, see pages 4-5

BRADY Customise-it See page 196 to order your custom-made signs.

Complies with EN ISO 7010

P044 : USE OF SMART GLASSES PROHIBITED

Clearly indicates that the wearing of smart glasses is not allowed at a facility for security or privacy reasons.



SIGNS

Order Ref.	Diameter (mm)	Total Qty/ Pack
Laminated Polyester		
198260	50	2 / Pack
198261	100	1 / Pack
198262	200	1 / Pack
198263	315	1 / Pack
Polypropylene		
198264	100	1 / Pack
198265	200	1 / Pack
198266	315	1 / Pack
Aluminium		
198267	100	1 / Pack
198268	200	1 / Pack
198269	315	1 / Pack

FLOOR MARKING

Order Ref.	Diameter (mm)	Total Qty/ Pack
Anti-skid Laminated Polyester		
198302	500	1 / Pack

MINI-PICTOGRAMS

Order Ref.	Diameter (mm)	Total Qty/ Pack
Laminated Polyester		
198296	20	18 / Pack
198297	25	7 / Pack
198298	30	15 / Pack
Vinyl		
198295	15	54 / Pack



PICTOGRAMS ON ROLLS

Order Ref.	Diameter (mm)	Total Qty/ Pack
Laminated Polyester		
198299	25	250 / Pack
198300	50	250 / Pack
198301	100	250 / Pack

SIGNS WITH TEXT

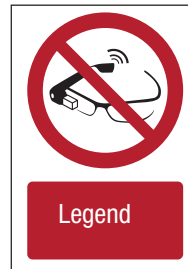

Order Ref.	Width (mm)	Height (mm)	Layout	Legend	Total Qty/ Pack
Laminated Polyester					
198270	150	50	Landscape	Do not use smart glasses	1 / Pack
198271	297	105	Landscape	Do not use smart glasses	1 / Pack
198272	450	150	Landscape	Do not use smart glasses	1 / Pack
198273	600	200	Landscape	Do not use smart glasses	1 / Pack
198274	148	210	Portrait	Do not use smart glasses	1 / Pack
198275	210	297	Portrait	Do not use smart glasses	1 / Pack
198276	297	420	Portrait	Do not use smart glasses	1 / Pack
Polypropylene					
198277	150	50	Landscape	Do not use smart glasses	1 / Pack
198278	297	105	Landscape	Do not use smart glasses	1 / Pack
198279	450	150	Landscape	Do not use smart glasses	1 / Pack
198280	600	200	Landscape	Do not use smart glasses	1 / Pack
198281	148	210	Portrait	Do not use smart glasses	1 / Pack
198282	210	297	Portrait	Do not use smart glasses	1 / Pack
198283	297	420	Portrait	Do not use smart glasses	1 / Pack
Aluminium					
198284	150	50	Landscape	Do not use smart glasses	1 / Pack
198285	297	105	Landscape	Do not use smart glasses	1 / Pack
198286	450	150	Landscape	Do not use smart glasses	1 / Pack
198287	148	210	Portrait	Do not use smart glasses	1 / Pack
198288	210	297	Portrait	Do not use smart glasses	1 / Pack
198289	297	420	Portrait	Do not use smart glasses	1 / Pack

PHOTOLUMINESCENT SIGNS



Order Ref.	Diameter (mm)	Total Qty/ Pack
Class B Photoluminescent Polyester		
198290	150	1 / Pack
Class C Photoluminescent Polyester		
198291	150	1 / Pack
Class B Photoluminescent Polypropylene		
198292	150	1 / Pack
Class C Photoluminescent Polypropylene		
198293	150	1 / Pack
Class C Photoluminescent Aluminium		
198294	150	1 / Pack

i For all material properties and applications, see pages 4-5

BRADY Customise-it See page 196 to order your custom-made signs.



P046 : Do NOT STRETCH OUT OF TOBOGGAN

This prohibition sign informs the general public of the proper code of conduct at a facility with a toboggan slide.



SIGNS

Order Ref.	Diameter (mm)	Total Qty/ Pack
Laminated Polyester		
197951	50	2 / Pack
197952	100	1 / Pack
197953	200	1 / Pack
197954	315	1 / Pack
Polypropylene		
197955	100	1 / Pack
197956	200	1 / Pack
197957	315	1 / Pack
Aluminium		
197958	100	1 / Pack
197959	200	1 / Pack
197960	315	1 / Pack

FLOOR MARKING

Order Ref.	Diameter (mm)	Total Qty/ Pack
Anti-skid Laminated Polyester		
197993	500	1 / Pack

MINI-PICTOGRAMS

Order Ref.	Diameter (mm)	Total Qty/ Pack
Laminated Polyester		
197987	20	18 / Pack
197988	25	7 / Pack
197989	30	15 / Pack
Vinyl		
197986	15	54 / Pack



PICTOGRAMS ON ROLLS

Order Ref.	Diameter (mm)	Total Qty/ Pack
Laminated Polyester		
197990	25	250 / Pack
197991	50	250 / Pack
197992	100	250 / Pack

SIGNS WITH TEXT



Order Ref.	Width (mm)	Height (mm)	Legend	Total Qty/ Pack
Laminated Polyester				
197961	150	50	Do not lean out of the toboggan	1 / Pack
197962	297	105	Do not lean out of the toboggan	1 / Pack
197963	450	150	Do not lean out of the toboggan	1 / Pack
197964	600	200	Do not lean out of the toboggan	1 / Pack
197965	148	210	Do not lean out of the toboggan	1 / Pack
197966	210	297	Do not lean out of the toboggan	1 / Pack
197967	297	420	Do not lean out of the toboggan	1 / Pack
Polypropylene				
197968	150	50	Do not lean out of the toboggan	1 / Pack
197969	297	105	Do not lean out of the toboggan	1 / Pack
197970	450	150	Do not lean out of the toboggan	1 / Pack
197971	600	200	Do not lean out of the toboggan	1 / Pack
197972	148	210	Do not lean out of the toboggan	1 / Pack
197973	210	297	Do not lean out of the toboggan	1 / Pack
197974	297	420	Do not lean out of the toboggan	1 / Pack
Aluminium				
197975	150	50	Do not lean out of the toboggan	1 / Pack
197976	297	105	Do not lean out of the toboggan	1 / Pack
197977	450	150	Do not lean out of the toboggan	1 / Pack
197978	148	210	Do not lean out of the toboggan	1 / Pack
197979	210	297	Do not lean out of the toboggan	1 / Pack
197980	297	420	Do not lean out of the toboggan	1 / Pack

PHOTOLUMINESCENT SIGNS



Order Ref.	Diameter (mm)	Total Qty/ Pack
Class B Photoluminescent Polyester		
197981	150	1 / Pack
Class C Photoluminescent Polyester		
197982	150	1 / Pack
Class B Photoluminescent Polypropylene		
197983	150	1 / Pack
Class C Photoluminescent Polypropylene		
197984	150	1 / Pack
Class C Photoluminescent Aluminium		
197985	150	1 / Pack

i For all material properties and applications, see pages 4-5

BRADY Customise-it See page 196 to order your custom-made signs.

Complies with EN ISO 7010

P047 : Do NOT RAM INTO TOBOGGAN

This prohibition sign informs the general public of the proper code of conduct at a facility with a toboggan slide.



SIGNS

Order Ref.	Diameter (mm)	Total Qty/ Pack
Laminated Polyester		
198054	50	2 / Pack
198055	100	1 / Pack
198056	200	1 / Pack
198057	315	1 / Pack
Polypropylene		
198058	100	1 / Pack
198059	200	1 / Pack
198060	315	1 / Pack
Aluminium		
198061	100	1 / Pack
198062	200	1 / Pack
198063	315	1 / Pack

FLOOR MARKING

Order Ref.	Diameter (mm)	Total Qty/ Pack
Anti-skid Laminated Polyester		
198096	500	1 / Pack

MINI-PICTOGRAMS

Order Ref.	Diameter (mm)	Total Qty/ Pack
Laminated Polyester		
198090	20	18 / Pack
198091	25	7 / Pack
198092	30	15 / Pack
Vinyl		
198089	15	54 / Pack



PICTOGRAMS ON ROLLS

Order Ref.	Diameter (mm)	Total Qty/ Pack
Laminated Polyester		
198093	25	250 / Pack
198094	50	250 / Pack
198095	100	250 / Pack

SIGNS WITH TEXT



Order Ref.	Width (mm)	Height (mm)	Legend	Total Qty/ Pack
Laminated Polyester				
198064	150	50	Do not ram into toboggan	1 / Pack
198065	297	105	Do not ram into toboggan	1 / Pack
198066	450	150	Do not ram into toboggan	1 / Pack
198067	600	200	Do not ram into toboggan	1 / Pack
198068	148	210	Do not ram into toboggan	1 / Pack
198069	210	297	Do not ram into toboggan	1 / Pack
198070	297	420	Do not ram into toboggan	1 / Pack
Polypropylene				
198071	150	50	Do not ram into toboggan	1 / Pack
198072	297	105	Do not ram into toboggan	1 / Pack
198073	450	150	Do not ram into toboggan	1 / Pack
198074	600	200	Do not ram into toboggan	1 / Pack
198075	148	210	Do not ram into toboggan	1 / Pack
198076	210	297	Do not ram into toboggan	1 / Pack
198077	297	420	Do not ram into toboggan	1 / Pack
Aluminium				
198078	150	50	Do not ram into toboggan	1 / Pack
198079	297	105	Do not ram into toboggan	1 / Pack
198080	450	150	Do not ram into toboggan	1 / Pack
198081	148	210	Do not ram into toboggan	1 / Pack
198082	210	297	Do not ram into toboggan	1 / Pack
198083	297	420	Do not ram into toboggan	1 / Pack

PHOTOLUMINESCENT SIGNS



Order Ref.	Diameter (mm)	Total Qty/ Pack
Class B Photoluminescent Polyester		
198084	150	1 / Pack
Class C Photoluminescent Polyester		
198085	150	1 / Pack
Class B Photoluminescent Polypropylene		
198086	150	1 / Pack
Class C Photoluminescent Polypropylene		
198087	150	1 / Pack
Class C Photoluminescent Aluminium		
198088	150	1 / Pack

i For all material properties and applications, see pages 4-5

BRADY Customise-it See page 196 to order your custom-made signs.



PIC 209 (=PIC 2110) : No ACCESS FOR UNAUTHORISED PERSONS

It is important to be able to limit access to certain spaces to authorised people. This limitation may be for safety reasons or just simply to keep some spaces 'private'.



SIGNS

Order Ref.	Diameter (mm)	Total Qty/Pack
Laminated Polyester		
250019	100	1 / Pack
250020	200	1 / Pack
222922	315	1 / Pack
Polypropylene		
222923	100	1 / Pack
Aluminium		
257999	100	1 / Pack
255016	200	1 / Pack
255017	315	1 / Pack

FLOOR MARKING

Order Ref.	Diameter (mm)	Total Qty/Pack
Anti-skid Laminated Polyester		
223653	500	1 / Pack



PICTOGRAMS ON ROLLS

Order Ref.	Diameter (mm)	Total Qty/Pack
Laminated Polyester		
251960	25	250 / Roll
223325	50	250 / Roll
223326	100	250 / Roll



SIGNS WITH TEXT

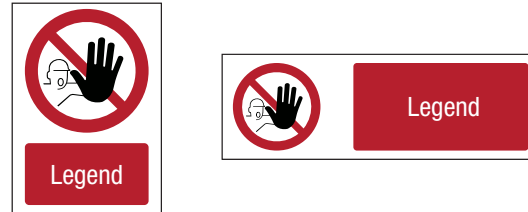

Order Ref.	Width (mm)	Height (mm)	Layout	Legend	Total Qty/ Pack
Polypropylene					
195924	148	210	Portrait	No access for unauthorised persons	1 / Pack
195922	150	450	Portrait	No access for unauthorised persons	1 / Pack
195923	210	297	Portrait	No access for unauthorised persons	1 / Pack

PHOTOLUMINESCENT SIGNS WITH TEXT



Order Ref.	Width (mm)	Height (mm)	Class	Legend	Total Qty/ Pack
Class B Photoluminescent Polyester					
836127	200	100	Class B	No admittance Authorised personnel only	1 / Pack
836128	250	100	Class B	No admittance Authorised personnel only	1 / Pack
Class B Photoluminescent Polypropylene					
836125	200	100	Class B	No admittance Authorised personnel only	1 / Pack
836126	250	100	Class B	No admittance Authorised personnel only	1 / Pack



PIC 900 : No SMOKING OF ELECTRONIC CIGARETTES

With the appearance of electronic cigarettes, it has been necessary to clarify the places where they are prohibited or authorised, to avoid any confusion. For information, the texts of interior laws and regulations generally prohibit smoking, without defining the nature of this smoking. This ban therefore applies to tobacco cigarettes and to electronic cigarettes.



SIGNS

Order Ref.	Diameter (mm)	Total Qty/Pack
Laminated Polyester		
138478	100	1 Sign(s) / Pack
138479	200	1 Sign(s) / Pack
Polypropylene		
138480	100	1 Sign(s) / Pack
138481	200	1 Sign(s) / Pack

SIGNS WITH TEXT



Order Ref.	Width (mm)	Height (mm)	Legend	Total Qty/ Pack
Laminated Polyester				
138482	210	297	No smoking of electronic cigarettes	1 / Pack
Polypropylene				
138487	210	297	No smoking of electronic cigarettes	1 / Pack



PICTOGRAMS ON ROLLS

Order Ref.	Diameter (mm)	Total Qty/Pack
Laminated Polyester		
138477	50	250 / Pack

TRAFFIC SIGNS

To encourage fluid and harmonised traffic flow between employees and visitors, Brady offers a range of parking signs which help with arrival, movement, directions, parking and accessibility for your space.

PIC 225 : NO PARKING



SIGNS

Order Ref.	Diameter (mm)	Total Qty/Pack
Laminated Polyester		
250051	100	1 / Pack
250052	200	1 / Pack
222928	315	1 / Pack
Polypropylene		
222929	100	1 / Pack
252049	200	1 / Pack
252050	315	1 / Pack
252051	400	1 / Pack
Aluminium		
241531	100	1 / Pack
241532	200	1 / Pack
241533	315	1 / Pack

FLOOR MARKING

Order Ref.	Diameter (mm)	Total Qty/Pack
Anti-skid Laminated Polyester		
223657	500	1 / Pack

PIC 228 : PROHIBITED FOR ALL TYPES OF VEHICLES



SIGNS

Order Ref.	Diameter (mm)	Total Qty/Pack
Laminated Polyester		
250057	100	1 / Pack
250058	200	1 / Pack
222926	315	1 / Pack
Polypropylene		
252059	315	1 / Pack
252060	400	1 / Pack
Aluminium		
241534	100	1 / Pack
241535	200	1 / Pack
255026	315	1 / Pack

PIC 226 : NO STOPPING (CLEARWAY)



SIGNS

Order Ref.	Diameter (mm)	Total Qty/Pack
Laminated Polyester		
250053	100	1 / Pack
250054	200	1 / Pack
222940	315	1 / Pack
Polypropylene		
252052	200	1 / Pack
252053	315	1 / Pack
252054	400	1 / Pack
Aluminium		
241548	100	1 / Pack
241549	200	1 / Pack
255024	315	1 / Pack

PIC 229 : NO ENTRY



SIGNS

Order Ref.	Diameter (mm)	Total Qty/Pack
Laminated Polyester		
250059	100	1 / Pack
250060	200	1 / Pack
222924	315	1 / Pack
Polypropylene		
222925	100	1 / Pack
252061	200	1 / Pack
252062	315	1 / Pack
252063	400	1 / Pack
Aluminium		
241529	100	1 / Pack
241530	200	1 / Pack
255027	315	1 / Pack

PIC 227 : NO WAITING



SIGNS

Order Ref.	Diameter (mm)	Total Qty/Pack
Laminated Polyester		
250055	100	1 / Pack
250056	200	1 / Pack
222930	315	1 / Pack
Polypropylene		
252056	315	1 / Pack
252057	400	1 / Pack
Aluminium		
241550	100	1 / Pack
241551	200	1 / Pack
255025	315	1 / Pack

MINI-PICTOGRAMS

Order Ref.	Diameter (mm)	Total Qty/Pack
Vinyl		
286814	15	54 / Pack
286688	24	18 / Pack

FLOOR MARKING

Order Ref.	Diameter (mm)	Total Qty/Pack
Anti-skid Laminated Polyester		
223658	500	1 / Pack

PICTOGRAMS ON ROLLS



Order Ref.	Diameter (mm)	Total Qty/Pack
Laminated Polyester		
223345	25	250 / Roll
223346	50	250 / Roll
223347	100	250 / Roll

i For all material properties and applications, see pages 4-5

BRADY Customise-it See page 196 to order your custom-made signs.